

ELEMENT™ 3" HALOGEN

ADJUSTABLE DOWNLIGHT

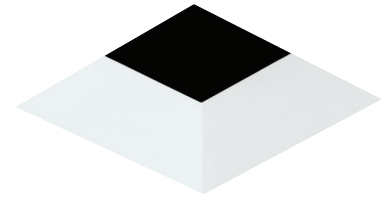

SHOWN IN FLANGELESS BEVEL SQUARE

Small aperture recessed downlight is fully adjustable with ELEMENT's unique patented high-low lamp positioning. The innovative design allows the lamp to be positioned closer to the aperture for maximum light output and efficiency or higher to minimize glare and flash on the trim. Additional adjustability allows for hot aiming including 0°- 40° tilt and 361° rotation to eliminate dead spots. All aiming functions are lockable. Wood ceiling option allows for a smooth, flangeless appearance using any flangeless trim.

- Patented high-low lamp positioning
- Hot aiming including 0°- 40° tilt and 361° rotation
- Flangeless wood ceiling option accommodates variable ceiling thickness
- Accepts 3 optical controls and an optional trim mounted lens
- Compatible with LED MR16 replacement lamp. LED MR16 requires no load electronic transformer (12 watt max)
- Power supplies can be accessed through the aperture
- Glare reducing snoot integrated
- Lensed and shower options include Solite soft focus lens at aperture

Installation

- Includes adjustable hanger bars. Includes butterfly brackets that attach to the side of the housing and are vertically adjustable with a wing nut
- Incorporates integral gunsights for positioning with laser level or string

SPECIFICATIONS

LAMP	Low-voltage Halogen MR16 (75W max in Non-IC, 50W max in IC housing). Compatible with LED MR16 replacement lamps.
WATTS (MAX)	Halogen: 75W Non-IC, 50W IC
VOLTAGE	120V or 277V
DIMMING ¹	ELV or MLV (Dimming dependent on transformer type)
POWER SUPPLY	Halogen: Electronic or Magnetic transformer. No load transformer required for LED MR16 compatibility (12 watt max in IC).
ADJUSTABILITY	0°-40° tilt, 361° rotation, and high-low lamp positioning
CEILING APPEARANCE	Flanged (Accommodates up to 2.5" drywall ceiling thickness, depending on trim), Flangeless or Flangeless in Wood Ceiling
CEILING APERTURE	3-7/8" ceiling cutout
HOUSING	IC Airtight, Non-IC, IC suitable up to R60 spray foam insulation
CONSTRUCTION	Housing: Heavy-gauge, cold-rolled steel Trim: Die-cast aluminum
FINISH	Housing: Black Trims: Antique Bronze, Black, Satin Nickel, White (paintable)
GENERAL LISTINGS	ETL Listed. Damp Location. Shower version Wet Listed.
WARRANTY ²	1 year

Ordering grids available on page 2.

¹See visualcomfort.com for dimmer compatibility.

²Visit visualcomfort.com for specific warranty limitations and details.



©2024 Visual Comfort & Co. All rights reserved. The Visual Comfort & Co. logo is a registered trademark.
Visual Comfort & Co. reserves the right to change specifications for product improvements without notification.

UPDATED 2/23/24

ELEMENT™ 3" HALOGEN

ADJUSTABLE DOWNLIGHT

ORDERING GRIDS

HOUSING

PRODUCT	CEILING APPEARANCE	LAMP	FUNCTION	HOUSING RATING	TRANSFORMER	WATTAGE RESTRICTION	VOLTAGE
E3R ELEMENT 3" ROUND	LF FLANGELESS	-H HALOGEN MR16	A ADJUSTABLE	I IC AIRTIGHT	E ELECTRONIC ²	NONE (LEAVE BLANK)	120 VOLT (LEAVE BLANK)
E3S ELEMENT 3" SQUARE	FF FLANGED WC WOOD CEILING ¹			N NON-IC AIRTIGHT	M MAGNETIC R REMOTE N NO LOAD ELECTRONIC ³	-WR WATTAGE RESTRICTION ⁴	-277 277 VOLT

Trims are required and must be ordered separately.
For dimming details, refer to dimmer compatibility chart.

IC not available with electronic transformer.

¹WC - Wood ceiling option accommodates flangeless trims only. Round not available with magnetic transformer.

²Standard electronic not available in IC.

³No load electronic suitable for IC with max 12 watt LED MR16 replacement lamp.

⁴To include wattage restriction label, specify -WR at the end of the housing item number and specify wattage (example: -WR37).

TRIM

PRODUCT	CEILING APPEARANCE	STYLE	APERTURE	FINISH
E3R ELEMENT 3" ROUND	L FLANGELESS	B BEVEL	-O NO LENS	Z ANTIQUE BRONZE
E3S ELEMENT 3" SQUARE	F FLANGED UP TO 1" CEILING THICKNESS F15 FLANGED 1.1"-1.5" CEILING THICKNESS F20 FLANGED 1.6"-2.0" CEILING THICKNESS F25 FLANGED 2.1"-2.5" CEILING THICKNESS	F FLAT	-H SHOWER ^{1,2} -L LENSED ²	B BLACK S SATIN NICKEL W WHITE

Wood ceiling option accommodates flangeless trims only.

¹H - Sauna/steam-room use available only with combination of H shower trim, LO output housing, and I IC housing rating. Shower lens includes a gasket.

²H, L - Lensed products come with Solite Soft Focus lens.

PLASTER PLATES

PRODUCT ¹	
150E3RPPLT-2	3" PLASTER PLATE ROUND DIE-CAST METAL ¹
150E3SPPLT-2	3" PLASTER PLATE SQUARE DIE-CAST METAL ¹
150E3RTPPLT-W	3" PLASTER PLATE ROUND SHEET METAL ²
150E3STPPLT-W	3" PLASTER PLATE SQUARE SHEET METAL ²

Used to convert flanged housings into flangeless housings.

¹Ships standard with flangeless housings.

²Optional, thinner, meshed sheet-metal mud plates available for minimized plaster feathering to meet installer preference.



ELEMENT™ 3" HALOGEN

ADJUSTABLE DOWNLIGHT

TRIMS

FLANGED

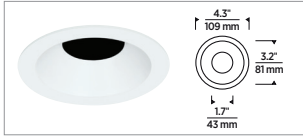

ROUND BEVEL

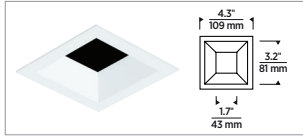

SQUARE BEVEL

FLANGELESS

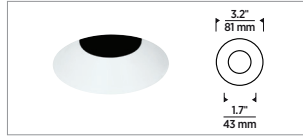

ROUND BEVEL

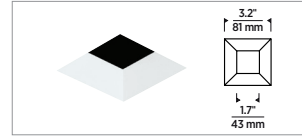

SQUARE BEVEL

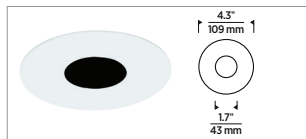

ROUND FLAT

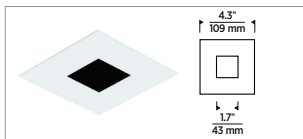

SQUARE FLAT

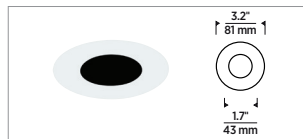

ROUND FLAT

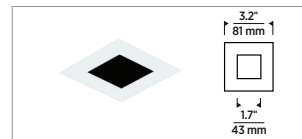

SQUARE FLAT

FINISH



ANTIQUE BRONZE



BLACK



SATIN NICKEL



WHITE (PAINTABLE)

FLANGELESS IN WOOD CEILING



ROUND BEVEL (ANTIQUE BRONZE)

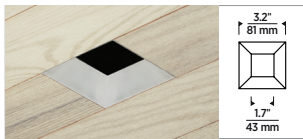

SQUARE BEVEL (SATIN NICKEL)



ROUND FLAT (ANTIQUE BRONZE)



SQUARE FLAT (SATIN NICKEL)

LENS OPTION



SHOWN WITH AND WITHOUT A LENS (SQUARE FLANGED BEVEL)



SHOWN WITH AND WITHOUT A LENS (ROUND FLANGELESS BEVEL)

HOUSING

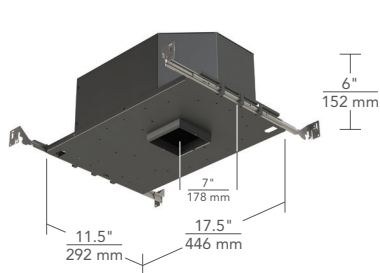

NON-IC

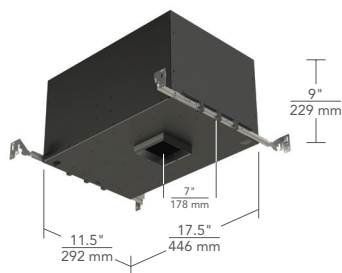

IC AIRTIGHT



ELEMENT™ 3" HALOGEN

ADJUSTABLE DOWNLIGHT

PLASTER PLATES

INCLUDED DIE-CAST

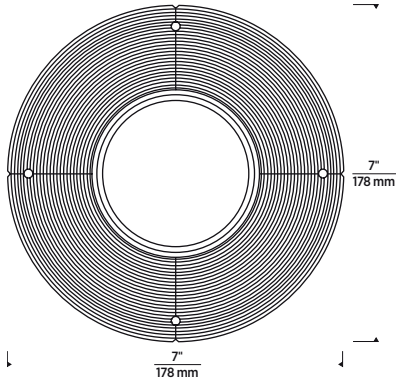

ROUND DIE-CAST (INCLUDED FOR FLANGELESS INSTALLATION)

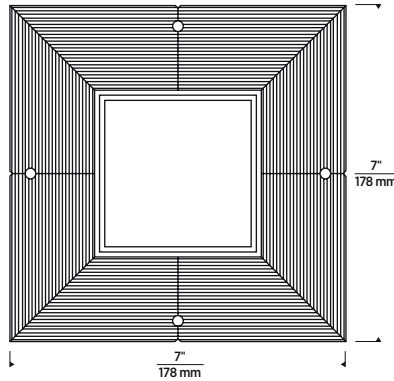

SQUARE DIE-CAST (INCLUDED FOR FLANGELESS INSTALLATION)

OPTIONAL SHEET METAL

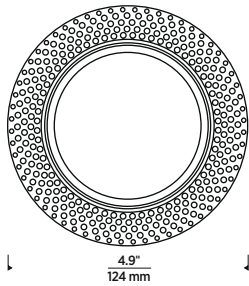

ROUND SHEET METAL (OPTIONAL FOR FLANGELESS INSTALLATION)

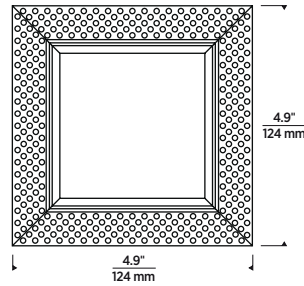

SQUARE SHEET METAL (OPTIONAL FOR FLANGELESS INSTALLATION)

FLANGELESS IN WOOD CEILING TRIM ADAPTER

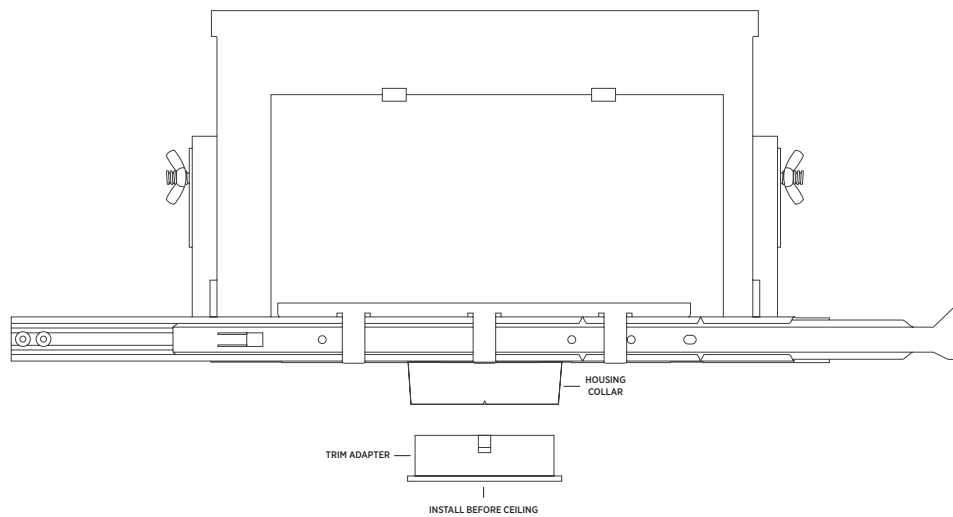

TRIM ADAPTER INSTALLED

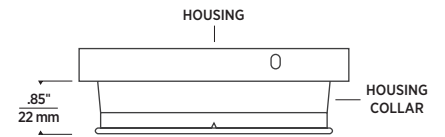

TRIM ADAPTER FLUSH

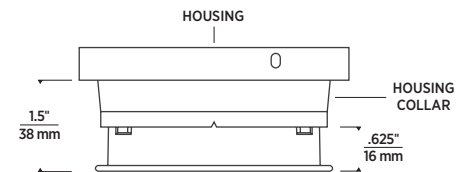

TRIM ADAPTER EXTENDED

Wood ceiling housings ("WC" designation in the ordering grid) ship with an adjustable trim adapter that inserts into the housing aperture and allows standard ELEMENT 3" flangeless trims to achieve a truly flangeless, flush ceiling appearance in special applications such as wood or stone installation. For use in new construction. Consult installation instructions regarding plenum requirements and ceiling thickness ratios.

ELEMENT™ 3" HALOGEN

ADJUSTABLE DOWNLIGHT

PROJECT INFORMATION

JOB NAME AND INFORMATION

FIXTURE TYPE AND QUANTITY

NOTES
