

ELEMENT™ 3" HALOGEN

DUAL ADJUSTABLE DOWNLIGHT

The ELEMENT 3" Halogen Dual Adjustable downlight provides high performance and beautiful small-aperture architectural appearance when design requirements for task or accent lighting require two closely spaced downlights with independent aiming capability. Designed to utilize the same trim pieces as the rest of the ELEMENT 3" series (two per housing), the ELEMENT 3" Halogen Dual Adjustable can be used in conjunction with the entire 3" family and remain undetectable. Complete independent adjustability allows for lockable hot aiming with 0°-40° tilt and 361° rotation of both lamps within a single housing. Patented high-low lamp positioning allows lamps to be positioned closer to the aperture for maximum light output or higher to minimize glare and flash on the trim. Wood ceiling option allows for a smooth, flangeless appearance using any flangeless trim.

- Lockable hot aiming with 0°-40° tilt and 361° rotation of both light modules
- Patented high-low lamp positioning
- Flangeless wood ceiling option accommodates variable ceiling thickness
- Accepts 3 optical controls and an optional trim mounted lens
- Compatible with LED MR16 replacement lamp. LED MR16 requires no load electronic transformer (12 watt max).
- Power supplies can be accessed through the aperture
- Glare reducing snoot integrated
- Lensed and shower options include Solite™ soft focus lens at aperture

Installation

- Includes adjustable hanger bars. Includes butterfly brackets that attach to the side of the housing and are vertically adjustable with a wing nut.
- Incorporates integral gunsights for positioning with laser level or string

SPECIFICATIONS

LAMP	Two low-voltage Halogen MR16 lamps per housing. Compatible with LED MR16 replacement lamps
WATTS (MAX.)	Halogen: 50w Non-IC/CP, 35w IC per socket
VOLTAGE	120V or 277V
DIMMING*	ELV or MLV (Dimming dependent on transformer type)
ADJUSTABILITY	0°-40° tilt, 361° rotation, and high-low lamp positioning
CEILING APPEARANCE	Flanged (Accommodates up to 2.5" drywall ceiling thickness, depending on trim) or Flangeless
CEILING APERTURE	3-7/8"
HOUSING	IC Airtight, Non-IC, Chicago Plenum IC suitable up to R60 spray foam insulation
POWER SUPPLY	Halogen: Electronic or Magnetic transformer. No load transformer required for LED MR16 compatibility (12 watt max in IC).
GENERAL LISTING	ETL listed. Damp listed. Shower version wet listed.
CONSTRUCTION	Housing: Heavy gauge cold rolled steel Trims: Die-cast aluminum
FINISH	Housing: Black Trims: Antique Bronze, Black, Satin Nickel, White (paintable)
WARRANTY**	1 year

*See ELEMENT-lighting.com for dimmer compatibility.

**Visit ELEMENT-lighting.com for specific warranty limitations and details.

Includes integral junction box approved for branch circuit through wiring.

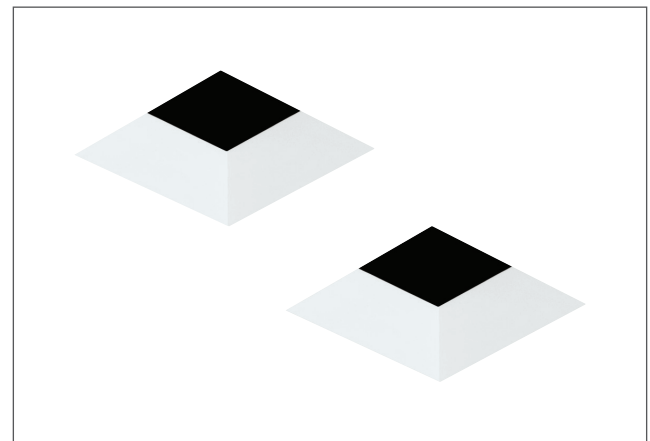

shown in flangeless bevel square

ELEMENT™ 3" HALOGEN

DUAL ADJUSTABLE DOWNLIGHT

GRIDS

HOUSING

PRODUCT SERIES	CEILING APPEARANCE	LAMP	FUNCTION	HOUSING RATING	TRANSFORMER	WATTAGE RESTRICTION (PER SOCKET)	VOLTAGE
E3R ELEMENT 3" ROUND	L FLANGELESS	-H HALOGEN	DA DUAL ADJUSTABLE	I IC AIRTIGHT*	E ELECTRONIC***	NONE (LEAVE BLANK)	120 120 VOLT
E3S ELEMENT 3" SQUARE	F FLANGED			N NON-IC AIRTIGHT*	M MAGNETIC	-WR WATTAGE RESTRICTION**	240 240 VOLT
	WC WOOD CEILING†			C CHICAGO PLENUM*	R REMOTE		277 277 VOLT
					N NO LOAD ELECTRONIC‡		

-H DA

TWO TRIMS ARE REQUIRED AND MUST BE ORDERED SEPARATELY.
 *IC: 35 WATT MAX PER SOCKET. NON-IC / CP: 50 WATT MAX PER SOCKET.
 **TO INCLUDE WATTAGE RESTRICTION, SPECIFY "-WR" AT THE END OF THE HOUSING ITEM NUMBER AND SPECIFY WATTAGE (EXAMPLE: -WR37).
 ***STANDARD ELECTRONIC NOT AVAILABLE WITH IC HOUSING.
 †WOOD CEILING OPTION ACCOMMODATES FLANGELESS TRIMS ONLY. ROUND NOT AVAILABLE WITH MAGNETIC TRANSFORMER.
 ‡NO LOAD ELECTRONIC SUITABLE FOR IC WITH MAX 12 WATT LED MR16 REPLACEMENT LAMP PER SOCKET.

TRIM

PRODUCT SERIES	CEILING APPEARANCE	TRIM STYLE	APERTURE	FINISH
E3R ELEMENT 3" ROUND	L FLANGELESS	B BEVEL	-O NO LENS	Z ANTIQUE BRONZE
E3S ELEMENT 3" SQUARE	F FLANGED UP TO 1" CEILING THICKNESS	F FLAT	-H SHOWER	B BLACK
	F15 FLANGED 1.1"-1.5" CEILING THICKNESS		-L LENSED	S SATIN NICKEL
	F20 FLANGED 1.6"-2.0" CEILING THICKNESS			W WHITE
	F25 FLANGED 2.1"-2.5" CEILING THICKNESS			

TWO TRIMS ARE REQUIRED PER HOUSING. WOOD CEILING OPTION ACCOMMODATES FLANGELESS TRIMS ONLY.

PROJECT INFO

FIXTURE TYPE & QUANTITY	JOB NAME & INFO	NOTES

TECH LIGHTING
 VISUAL COMFORT & Co.

7400 Linder Avenue, Skokie, Illinois 60077
 T 847.410.4400 F 847.410.4500

TRIMS

ROUND

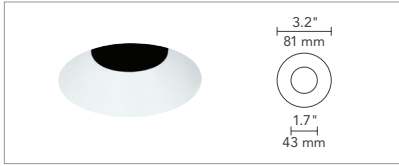

FLANGELESS BEVEL

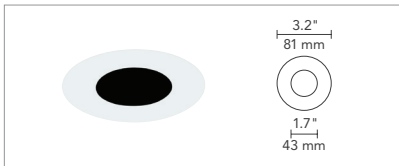

FLANGELESS FLAT

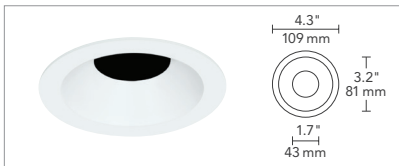

FLANGED BEVEL

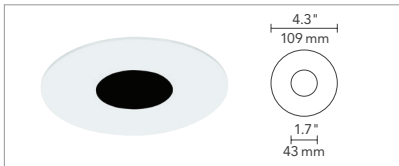

FLANGED FLAT

SQUARE

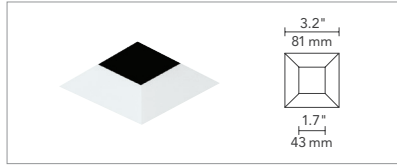

FLANGELESS BEVEL

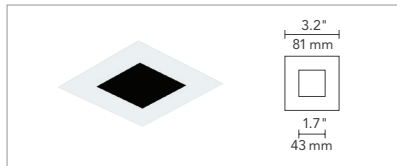

FLANGELESS FLAT

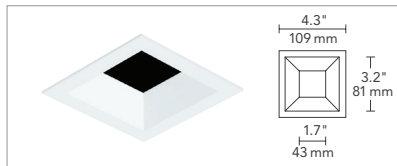

FLANGED BEVEL

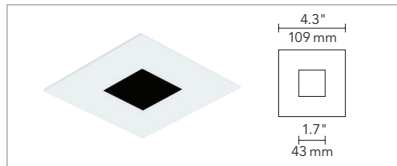

FLANGED FLAT

FINISH

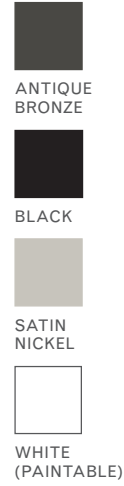

3" HOUSING

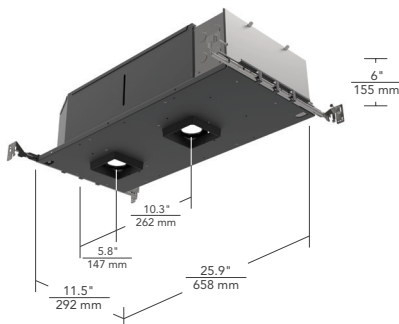

IC AIRTIGHT / NON-IC / CHICAGO PLENUM

WOOD CEILING OPTIONS / FLANGELESS TRIMS

ROUND



FLANGELESS BEVEL (ANTIQUE BRONZE)

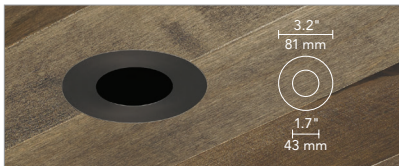

FLANGELESS FLAT (ANTIQUE BRONZE)



FLANGELESS BEVEL (SATIN NICKEL)



FLANGELESS FLAT (SATIN NICKEL)

SQUARE

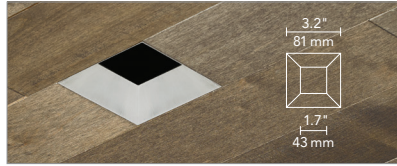

FLANGELESS BEVEL (ANTIQUE BRONZE)



FLANGELESS FLAT (ANTIQUE BRONZE)



FLANGELESS BEVEL (SATIN NICKEL)



FLANGELESS FLAT (SATIN NICKEL)

FINISH

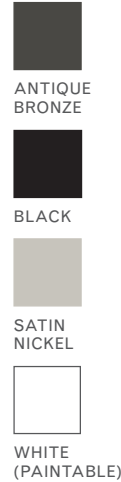

ADJUSTABLE TRIM ADAPTER

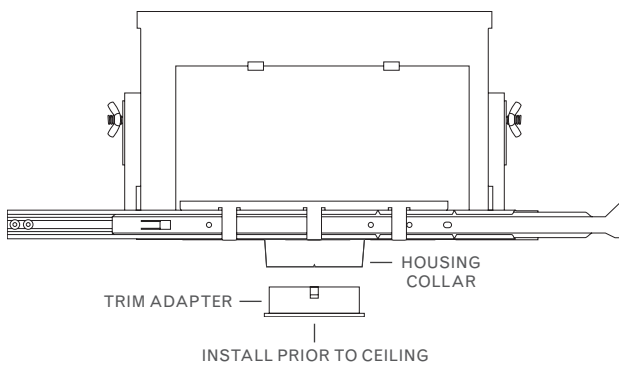

TRIM ADAPTER INSTALLED

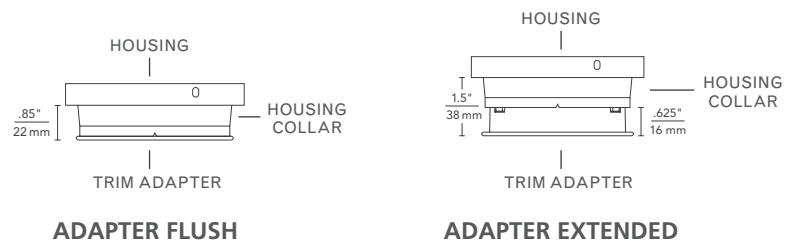

Wood ceiling housings (“WC” designation in the ordering grid) ship with an adjustable trim adapter that inserts into the housing aperture and allows standard ELEMENT 3” flangeless trims to achieve a truly flangeless, flush ceiling appearance in special applications such as wood or stone installation. For use in new construction.

Consult installation instructions regarding plenum requirements and ceiling thickness ratios.