

# ELEMENT™ 4" PRO SERIES LED

## ADJUSTABLE DOWNLIGHT

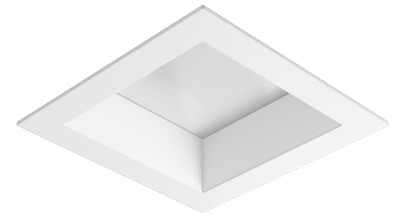

SHOWN IN FLANGED BEVEL SQUARE

The Element 4" Pro Series Adjustable Downlight features full adjustability with lockable, tool-free hot aiming, including patented high/low lamp positioning. Engineered with a precision diffuser and Solite Soft Focus lens that eliminates hot spots, direct visibility into the housing, and delivers a clean aperture and ceiling aesthetic. Complementing the Element 4" Pro Series Fixed downlight, the Adjustable is offered in a variety of options, including output, beam spreads and the choice of Static White, Warm Dim or Tunable White to complete any commercial installation.

- 1-step static white, 2-step warm dim and tunable white
- Solite Soft Focus Lens plus diffuser standard
- Tool-free aiming/locking: 0-40° tilt, 361° rotation
- Patented high/low lamp positioning
- Lutron/eldoLED options

### LUMEN MULTIPLIER (CRI/CCT)

CCT	80 CRI MULTIPLIER	90 CRI MULTIPLIER
2700K	0.95	0.80
3000K	1.00	0.85
3500K	1.05	0.90

Lumen output will vary by CCT and CRI. See photometric charts for output information.

### SPECIFICATIONS

WATTAGE	STATIC WHITE		WARM DIM		TUNABLE WHITE	
	Lumens	Efficacy	Lumens	Efficacy	Lumens	Efficacy
8W	675	84	551	70	464	58
12W	990	83	826	70	697	58
17W	1350	79	1170	69	987	58
24W	1800	75	1569	65	1393	58
29W	2430	84	2137	69	1800	62
36W	2880	80	NA		NA	
CRI	80+, 90+		90+		90+	
CCT	2700K, 3000K, 3500K, or 4000K		3000K - 1800K		4000K - 1800K or 5000K - 2700K	
COLOR CONSISTENCY	1-step		2-step		2-step	
VOLTAGE	120V or 277V					
DIMMING <sup>1</sup>	Standard reverse-phase, forward-phase, TRIAC, and 0-10V dimming down to 1% or 5%+ depending on wattage EldoLED 0-10V or DALI-2 down to 0.1% Lutron Hi-lume EcoSystem down to 0.1%				EldoLED 0-10V or DALI-2 down to 0.1%	
POWER SUPPLY	Constant current driver with +.9 power factor and +80% efficiency					
BEAM SPREAD	18°, 25°, 40°, or 60°					
ADJUSTABILITY	0-40° tilt, 361° rotation, high/low lamp positioning, 45° collar rotation					
CEILING APPEARANCE	Flanged, flangeless, flangeless in wood ceiling					
CEILING THICKNESS	Flanged: Up to 2-1/2" Flangeless: No ceiling thickness limitations   Flangeless in wood ceiling: No ceiling thickness limitations Note: Thicker ceilings impact light cut off					
CEILING APERTURE	4-1/2" ceiling cutout					
HOUSING	IC Airtight, Non-IC Airtight, or Chicago Plenum, IC suitable up to R60 spray foam insulation					
CONSTRUCTION	Housing: Heavy-gauge, cold-rolled steel   Trims: Die-cast aluminum					
FINISH	Housing: Black powder coat   Trim: Select finish options for bevel and flange separately: White, Black, or Haze Silver					
GENERAL LISTINGS	ETL Listed. Damp Location.					
CALIFORNIA TITLE 24	Registered CEC Appliance Database. Complies with CEC 2019 Title 24 Part 6 (JA8-2016, JA8-2019) (for 90 CRI versions).					
L70	50,000 hours min					
WARRANTY <sup>2</sup>	5 years					

Data in chart reflects 3000K/80CRI values unless noted. Lumen values are delivered lumens, not source lumens. Custom output/custom RAL/custom CCT available, contact Quotes Department.

Ordering grids available on page 2.

<sup>1</sup>See visualcomfort.com for dimmer compatibility.

<sup>2</sup>Visit visualcomfort.com for specific warranty limitations and details.

# ELEMENT™ 4" PRO SERIES LED

## ADJUSTABLE DOWNLIGHT

### ORDERING GRIDS

#### HOUSING

PRODUCT	CEILING APPEARANCE	OUTPUT	CRI/CCT	BEAM SPREAD	FUNCTION	HOUSING RATING	DRIVER	VOLTAGE
<b>E4PR</b> ELEMENT 4" PRO SERIES ROUND	<b>L</b> FLANGELESS	<b>-L08</b> 8W (675 LMS) <sup>2</sup>	<b>830</b> 80 CRI, 3000K, 1-STEP	<b>1</b> 18°	<b>A</b> ADJUSTABLE	<b>I</b> IC AIRTIGHT	<b>INTEGRATED DRIVERS 120V/277V</b> UNIVERSAL PHASE/0-10V 1-5% (LEAVE BLANK) <sup>6</sup>	120 VOLT (LEAVE BLANK)
	<b>F</b> FLANGED	<b>835</b> 80 CRI, 3500K, 1-STEP	<b>2</b> 25°	<b>N</b> NON-IC AIRTIGHT				
<b>E4PS</b> ELEMENT 4" PRO SERIES SQUARE	<b>WC</b> WOOD CEILING <sup>1</sup>	<b>-L12</b> 12W (990 LMS)	<b>840</b> 80 CRI, 4000K, 1-STEP	<b>4</b> 40°	<b>A</b> ADJUSTABLE	<b>C</b> CHICAGO PLENUM	<b>-ELDO</b> ELDOLED 0.1% 0-10V LINEAR <b>-ELDOA</b> ELDOLED 0.1% 0-10V LOGARITHMIC <b>-ELDD</b> ELDOLED 0.1% DALI-2 <b>-ELTO</b> ELDOLED TUNABLE WHITE 0.1% 0-10V LINEAR <sup>4</sup> <b>-ELTD</b> ELDOLED TUNABLE WHITE 0.1% DALI-2 <sup>4</sup> <b>-HLECO</b> LUTRON HI-LUME 0.1% ECOSYSTEM <sup>7</sup>	<b>-2</b> 277 VOLT
		<b>-L17</b> 17W (1350 LMS)	<b>927</b> 90 CRI, 2700K, 1-STEP	<b>6</b> 60°		<b>E</b> EMERGENCY		
		<b>-L24</b> 24W (1800 LMS)	<b>930</b> 90 CRI, 3000K, 1-STEP			BATTERY BACKUP (NON-IC AIRTIGHT/ CHICAGO PLENUM) <sup>5</sup>		
		<b>-L29</b> 29W (2430 LMS)	<b>935</b> 90 CRI, 3500K, 1-STEP					
		<b>-L36</b> 36W (2880 LMS) <sup>3</sup>	<b>940</b> 90 CRI, 4000K, 1-STEP					
			<b>WD31</b> 90 CRI, 3000K-1800K, WARM DIM, 2-STEP					
			<b>TW52</b> 90 CRI, 5000K-2700K, TUNABLE WHITE, 2-STEP <sup>4</sup>					
		<b>TW41</b> 90 CRI, 4000K-1800K, TUNABLE WHITE, 2-STEP <sup>4</sup>						

Trims are required and must be ordered separately.

Output lists nominal wattage and lumens at 3000K/80CRI, actual wattage and lumens may vary slightly.

<sup>1</sup>WC - Wood ceiling accommodates Flangeless trims only. For flanged trims in a wood ceiling use standard flanged housing.

<sup>2</sup>L08 - Dimming performance with standard universal phase/0-10V driver varies dramatically from <1% to >10% depending on the dimmer; please refer to dimmer compatibility chart.

<sup>3</sup>L36 - Output available non-IC/CP only. Not available with HLECO driver. Not available with WD31 warm dim or TW52/TW41 tunable white.

<sup>4</sup>TW52/TW41 - Tunable white available with ELTO (0-10V, linear) or ELTD (DALI-2) only. For 0-10V logarithmic dimming consult Quotes Department.

<sup>5</sup>E - Emergency battery backup housing available in E4NGEMH housing only.

<sup>6</sup>Universal dimming is reverse-phase, forward-phase, TRIAC, and 0-10V. 277V is only compatible with 0-10V dimming. The standard universal phase/0-10V driver dims to 1% with L12 and L17, and to 5% with L08, L24, L29 and L36. Dimming performance varies by dimmer; please refer to dimmer compatibility chart.

<sup>7</sup>HLECO - Lutron EcoSystem available IC only for L08, L12, and L17 output. Available with WD31 warm dim only for L12 and L17 output. Not available for L36 output.

#### TRIM

PRODUCT	CEILING APPEARANCE	STYLE	FUNCTION	BEVEL FINISH	FLANGE FINISH
<b>E4PR</b> ELEMENT 4" PRO SERIES ROUND	<b>L</b> FLANGELESS	<b>R</b> REGRESS (1.0")	<b>A</b> ADJUSTABLE	<b>-W</b> WHITE	FLANGELESS ONLY
	<b>F</b> FLANGED			<b>-B</b> BLACK	(LEAVE BLANK)
<b>E4PS</b> ELEMENT 4" PRO SERIES SQUARE	<b>F15</b> FLANGED 1.1"-1.5" CEILING THICKNESS	<b>R</b>	<b>A</b>	<b>-HS</b> HAZE	<b>W</b> WHITE
	<b>F20</b> FLANGED 1.6"-2.0" CEILING THICKNESS			SILVER	<b>B</b> BLACK
	<b>F25</b> FLANGED 2.1"-2.5" CEILING THICKNESS				

#### REPLACEMENT OPTICS

PRODUCT	BEAM SPREAD
<b>353E4LEDCOPT</b>	<b>18</b> 18° <b>25</b> 25° <b>40</b> 40° <b>60</b> 60°

#### 353E4LEDCOPT

#### PLASTER PLATES

PRODUCT	PRODUCT
<b>150E4RPPLT</b>	ROUND PLASTER PLATE
<b>150E4SPPLT</b>	SQUARE PLASTER PLATE

Plaster plates are used to convert flanged housings into flangeless housings. Ships standard with flangeless housings.



# ELEMENT™ 4" PRO SERIES LED ADJUSTABLE DOWNLIGHT

## TRIMS

### ROUND

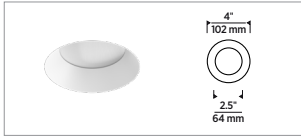

FLANGELESS

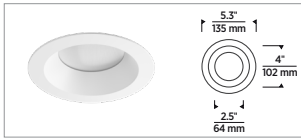

FLANGED

### SQUARE

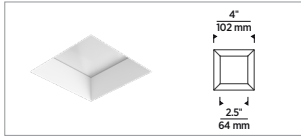

FLANGELESS

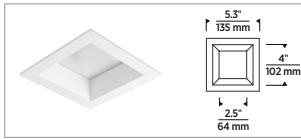

FLANGED

## FINISH OPTIONS

### NO FLANGE



HAZE SILVER BEVEL

### WHITE FLANGE



WHITE FLANGE, HAZE SILVER BEVEL

### BLACK FLANGE

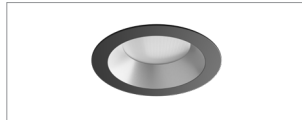

BLACK FLANGE, HAZE SILVER BEVEL

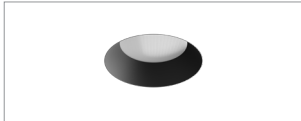

BLACK BEVEL



WHITE FLANGE, BLACK BEVEL

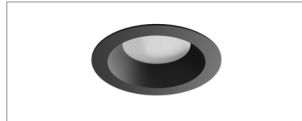

BLACK FLANGE, BLACK BEVEL



WHITE BEVEL



WHITE FLANGE, WHITE BEVEL

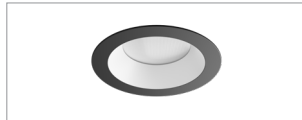

BLACK FLANGE, WHITE BEVEL

## WARM DIM CURVE

CCT vs. Forward Current,  $T_c=25^\circ\text{C}$

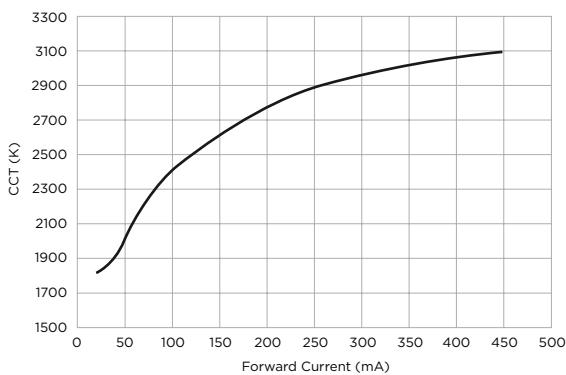

# ELEMENT™ 4" PRO SERIES LED ADJUSTABLE DOWNLIGHT

## HOUSINGS

E4NGH

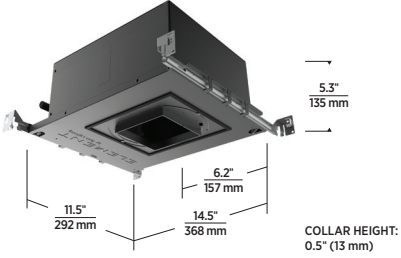

IC AIRTIGHT / NON-IC AIRTIGHT / CHICAGO PLENUM

E4NGEMH

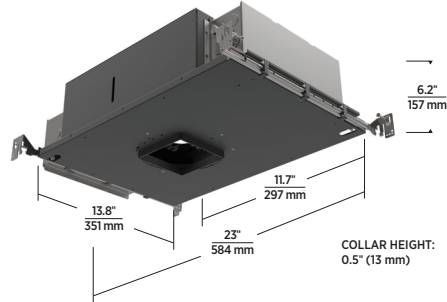

EMERGENCY BATTERY BACKUP  
 (NON-IC / CHICAGO PLENUM)

## PLASTER PLATES

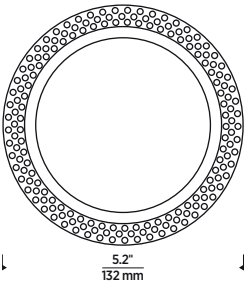

ROUND SHEET METAL MUD/PLASTER  
 PLATE IS INCLUDED FOR FLANGELESS  
 INSTALLATION

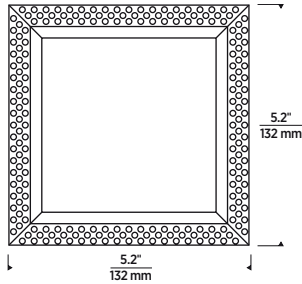

SQUARE SHEET METAL MUD/PLASTER  
 PLATE IS INCLUDED FOR FLANGELESS  
 INSTALLATION

## FLANGELESS IN WOOD CEILING INSTALLATION

