

ELEMENT™ 3" CYLINDER

FIXED CYLINDER

The ELEMENT 3" Fixed Cylinder is designed to provide a premium modern aesthetic and superior lighting performance for a wide range of applications, including residential, hospitality, and commercial spaces. With its sleek design and versatile mounting options, this lighting solution is perfect for exposed ceiling applications. The interchangeable optics and recessed LED ensure minimal glare, while offering the flexibility of warm dimming and static white lighting options.

- Interchangeable optics: 18°, 25°, 40°, and 60°
- 1-step static white and 2-step warm dim color binning
- Available in 2" and 3" fixed and adjustable options; 3" available in wall wash
- Flush, surface, conduit, cord, and pendant mount options
- Several lens and louver options including Solite Soft Focus
- Decorative trims available in natural brass, crystal, walnut, weathered oak wood, and alabaster



SHOWN IN BLACK

LUMEN MULTIPLIER (CRI/CCT)

CCT	80 CRI MULTIPLIER	90 CRI MULTIPLIER
2700K	—	0.98
3000K	—	1.00
3500K	1.21	—

Lumen output will vary by CCT and CRI. See photometric charts for output information. Data in chart reflects 3000K/90 CRI values, unless otherwise noted.

SPECIFICATIONS

	STATIC WHITE	WARM DIM
WATTAGE	Lumens	Efficacy
12W	1167	98
15W	1504	95
19W	1771	90
27W	2324	86
CRI	80+, 90+	90+
CCT	2700K, 3000K, or 3500K	3000K - 1800K
COLOR CONSISTENCY	1-step	2-step
VOLTAGE	120V or 277V	
DIMMING¹	Standard reverse-phase, forward-phase, TRIAC, and 0-10V dimming down to 1% eLdoLED 0-10V or DALI-2 down to 0.1% Lutron Hi-lume EcoSystem down to 0.1%	
POWER SUPPLY	Constant current driver with +0.9 power factor and +80% efficiency	
BEAM SPREAD	Interchangeable optics: 18°, 25°, 40°, or 60°	
CEILING APPEARANCE	Flush mount Surface mount (canopy) Pendant mount (canopy) Conduit mount (j-box) Cord mount (canopy)	
CONSTRUCTION	Cylinder: Aluminum	
FINISH	White or Black	
GENERAL LISTINGS	ETL Listed. Damp Location.	
CALIFORNIA TITLE 24	Registered CEC appliance database. Complies with CEC 2019 Title 24 Part 6 (JA8-2016, JA8-2019) (for 90 CRI versions).	
L70	50,000 hours min	
WARRANTY²	5 years	

Data in chart reflect 3000K/90 CRI values, unless otherwise noted.

Ordering grids available on page 2.

¹See visualcomfort.com for dimmer compatibility.

²Visit visualcomfort.com for specific warranty limitations and details.

ELEMENT™ 3" CYLINDER

FIXED CYLINDER

ORDERING GRIDS

CYLINDER

PRODUCT	MOUNTING	OUTPUT	CRI/CCT	BEAM SPREAD	FUNCTION	REFLECTOR	DRIVERS ⁶	CYLINDER FINISH
EC3R ELEMENT CYLINDERS 3" ROUND	F FLUSH MOUNT 1	-12 12W	835 80 CRI, 3500, 1-STEP	1 18°	D FIXED DOWNLIGHT	N NO LENS L LENSED/DECORATIVE ⁵	DRIVERS 120V/277V	-B BLACK -W WHITE
	S SURFACE MOUNT (CANOPY)	-15 15W	927 90 CRI, 2700K, 1-STEP	2 25°			-UNV UNIVERSAL PHASE/0-10V 1% ⁷	
	P PENDANT MOUNT (CANOPY) ²	-19 19W	930 90 CRI, 3000K, 1-STEP	4 40°			-ELDO ELDOLED 0.1% 0-10V LINEAR	
	D CORD MOUNT (CANOPY) ³	-27 27W	9WD31 90 CRI, WARM DIM, 3000-1800K, 2-STEP	6 60°			-ELD0A ELDOLED 0.1% 0-10V LOGARITHMIC	
	C CONDUIT MOUNT (J-BOX) ⁴						-ELDD ELDOLED 0.1% DALI-2 -HLECO LUTRON HI-LUME 0.1% ECOSYSTEM	
EC3R	-			D	-			

For dimming details, refer to dimmer compatibility chart.

¹F - Flush Mount includes adapter plate to convert junction box before ceiling install and a remote driver enclosure for all driver options.

²P - Pendant Mount for use with ECPS Cylinders pendant stems. See part numbers below.

³D - Cord Mount includes 6 ft. of cord. Contact Quotes Department for longer cord lengths.

⁴C - Conduit Mount includes custom junction box assembled at/below the ceiling.

⁵Standard Cylinder Reflectors do not accommodate lens accessories. Lens/louvers and decorative accessories ordered separately (see part numbers below). Limit 1 optical element. Lenses and louvers are not compatible with decorative accessories. To use with a lens/louver accessory order ELCY3K kit. To use with a decorative accessory order EC3DA kit and specify finish.

⁶The drivers in ELEMENT Cylinders must be located either in the junction box or in a remote location. Reference the Driver J-Box Compatibility Chart below for guidance. When the driver is listed as Remote, a remote enclosure that is 4" x 8" x 1.8" is provided. All non-UNV drivers are remote. All flush and conduit drivers are remote.

⁷UNV - Universal dimming is reverse-phase, forward-phase, TRIAC, and 0-10V. 277V is only compatible with 0-10V dimming. Surface, Pendant, and Cord Mounts place the UNV driver in the junction box for the 12W and 15W outputs. For the 19W and 27W outputs a remote driver enclosure is included for locating the UNV driver.

DRIVER J-BOX COMPATIBILITY CHART

	12W AND 15W UNIVERSAL	19W AND 27W UNIVERSAL	12W, 15W, 19W, 27W LUTRON/ELDOLED
3" FLUSH MOUNT (CANOPY)			
4" OCTAGON	REMOTE		REMOTE
4" SQUARE	FITS SNUGLY IN J-BOX	REMOTE	REMOTE
20 CU IN CEILING BOX	FITS IN J-BOX		
3" SURFACE MOUNT (CANOPY) PENDANT MOUNT (CANOPY)			
4" OCTAGON		REMOTE	
4" SQUARE	FITS IN J-BOX	FITS SNUGLY IN J-BOX	REMOTE
20 CU IN CEILING BOX		FITS SNUGLY IN J-BOX	
3" CONDUIT MOUNT (J-BOX) CORD MOUNT (CANOPY)			
4" OCTAGON			
4" SQUARE	REMOTE	REMOTE	REMOTE
20 CU IN CEILING BOX			

LENS/LOUVER KIT

PRODUCT ¹	TYPE	REFLECTOR FINISH
ELCY3LK	SF SOLITE SOFT FOCUS LENS	B BLACK
	SB SANDBLASTED LENS	W WHITE
	LL LINEAR SPREAD LENS	
	DF DIFFUSER LENS	
	EC EGGCRATE/HEXCELL LOUVER	

ELCY3LK

¹Required for use with lenses or louvers. Kit includes a reflector and one lens or louver. For use with Lensed Reflector Cylinders or to convert a No Lens Reflector. Replacement lenses and louvers can be ordered separately. ELEMENT Cylinders accommodate one lens or louver. Lens/louver kit is not compatible with decorative accessories.

REPLACEMENT LENSES FOR LENS/LOUVER KIT

PRODUCT ¹	
140MR16SF	SOLITE SOFT FOCUS LENS
140MR16SB	SANDBLASTED LENS
140MR16LL	LINEAR SPREAD LENS
140MR16DF	DIFFUSER LENS
EL2RHCBK	EGGCRATE/HEXCELL LOUVER

¹Lenses and louvers are not compatible with decorative accessories.

REPLACEMENT OPTICS

PRODUCT	BEAM SPREAD
353E4LEDCOPT	18 18°
	25 25°
	40 40°
	60 60°

353E4LEDCOPT

PENDANT STEMS

PRODUCT ¹	LENGTH ²	FINISH
ECPS	12 12"	B BLACK
	24 24"	W WHITE
	36 36"	
	48 48"	
	60 60"	
	72 72"	

ECPS

¹Required for Pendant Mount only.

²Consult Quotes Department for custom lengths to the inch.

CYLINDERS DECORATIVE ACCESSORIES

PRODUCT ¹	FINISH
EC3DA	SNB SOLID NATURAL BRASS
	INB INNER CYLINDER NATURAL BRASS
	KNB KNURLED NATURAL BRASS
	CLC CLEAR CRYSTAL
	WAW WALNUT WOOD
	WOW WEATHERED OAK WOOD
	ALB ALABASTER

EC3DA

¹For use with Lensed Reflector Cylinders or to convert a No Lens Reflector Cylinder. Lenses and louvers are not compatible with decorative accessories.

VAULTED CEILING ADAPTER

PRODUCT	FINISH
ELCVA PENDANT MOUNT ¹	B BLACK W WHITE

¹For use with Pendant Mount Cylinder with or without Stems. Accommodates slopes up to 45 degrees. Adds 1.7" to the overall length of the stem.

ELEMENT™ 3" CYLINDER

FIXED CYLINDER

DECORATIVE ACCESSORIES



CLEAR CRYSTAL



SOLID NATURAL BRASS



WALNUT WOOD



INNER CYLINDER NATURAL BRASS



WEATHERED OAK WOOD



KNURLED NATURAL BRASS



ALABASTER

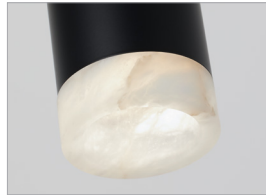

ELEMENT™ 3" CYLINDER

FIXED CYLINDER

CYLINDERS

FLUSH MOUNT

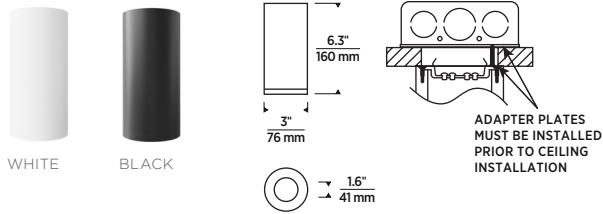

CONDUIT MOUNT (J-BOX)

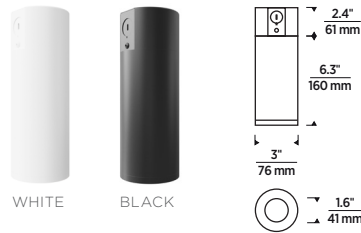

SURFACE MOUNT (CANOPY)

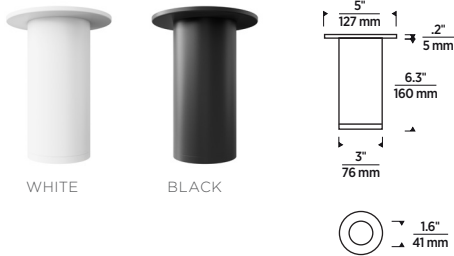

PENDANT MOUNT (CANOPY)

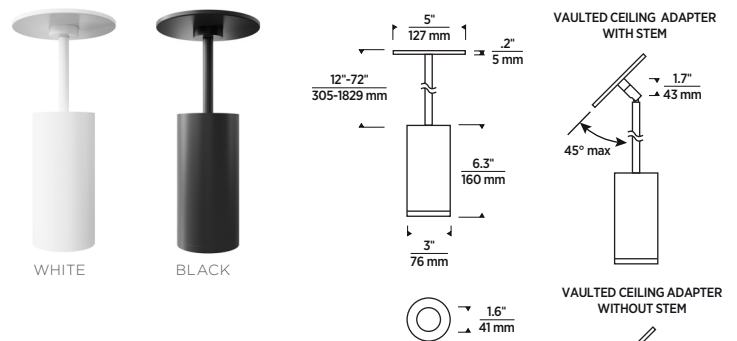

CORD MOUNT (CANOPY)

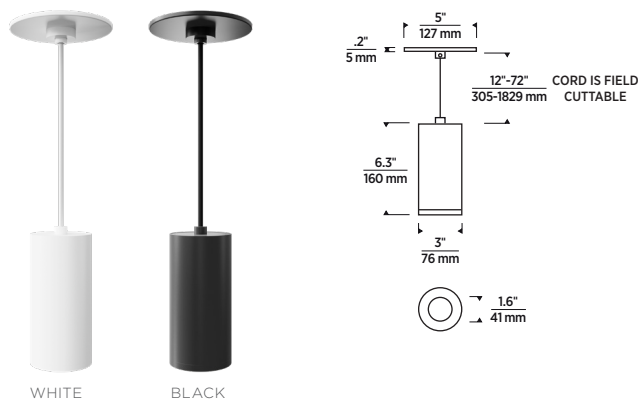

REMOTE DRIVER J-BOX

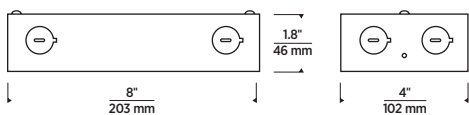

ELEMENT™ 3" CYLINDER

FIXED CYLINDER

PHOTOMETRICS

Description: 3" Cylinder Fixed
18° Beam
90 CRI, 3000K

Input Power (Watts): 19.7
Input Power Factor: 0.99
Absolute Luminous Flux (Lumens): 1405
Lumen Efficacy (Lumens per Watt): 71

Output difference between CCTs - 5%, CRIs - 15%.

Description: 3" Cylinder Fixed
25° Beam
90 CRI, 3000K

Input Power (Watts): 19.7
Input Power Factor: 0.99
Absolute Luminous Flux (Lumens): 1694
Lumen Efficacy (Lumens per Watt): 86

Description: 3" Cylinder Fixed
40° Beam
90 CRI, 3000K

Input Power (Watts): 19.7
Input Power Factor: 0.99
Absolute Luminous Flux (Lumens): 1797
Lumen Efficacy (Lumens per Watt): 91

ANGLE	0°	45°	90°
0°	5090	5090	5090
5°	4570	4495	4591
10°	3264	3165	3260
15°	2051	1982	2038
20°	1205	1165	1200
25°	638	608	636
30°	323	299	314
35°	172	158	166
40°	87	79	83
45°	47	44	46
50°	27	25	26
55°	15	15	15
60°	14	13	13
65°	10	9	9
70°	3	3	3
75°	2	2	2
80°	1	1	1
85°	1	1	1
90°	0	0	0

ANGLE	0°	45°	90°
0°	5246	5246	5246
5°	5080	4988	5010
10°	4357	4166	4194
15°	2941	2715	2768
20°	1556	1408	1456
25°	765	686	709
30°	379	342	350
35°	184	169	171
40°	84	77	79
45°	43	40	41
50°	23	20	22
55°	11	10	11
60°	8	8	8
65°	6	6	6
70°	3	2	3
75°	2	2	2
80°	1	1	1
85°	1	0	0
90°	0	0	0

ANGLE	0°	45°	90°
0°	3513	3513	3513
5°	3454	3454	3454
10°	3220	3204	3212
15°	2780	2757	2735
20°	2155	2094	2057
25°	1266	1210	1207
30°	586	550	564
35°	266	243	251
40°	129	117	118
45°	61	57	58
50°	26	24	25
55°	10	10	10
60°	8	7	7
65°	5	5	5
70°	2	2	2
75°	2	2	2
80°	1	1	1
85°	1	0	1
90°	0	0	0

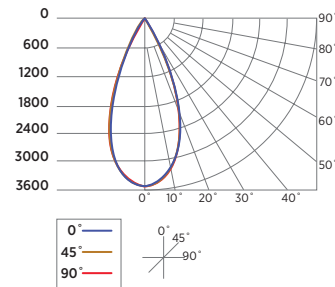
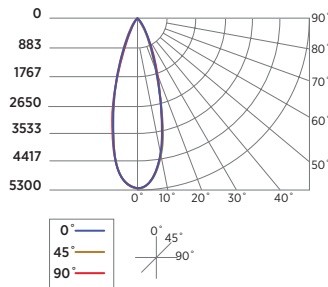
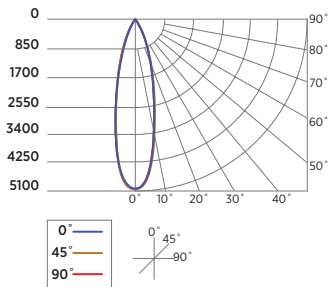
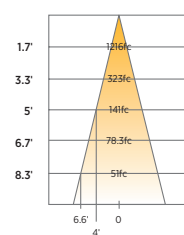
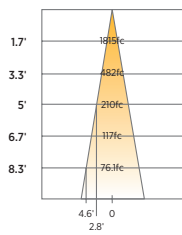
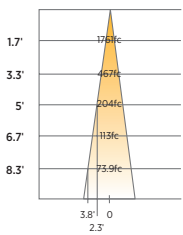

ELEMENT™ 3" CYLINDER

FIXED CYLINDER

PHOTOMETRICS

Description: 3" Cylinder Fixed
60° Beam
90 CRI, 3000K

Input Power (Watts): 19.7

Input Power Factor: 0.99

Absolute Luminous Flux (Lumens): 1599

Lumen Efficacy (Lumens per Watt): 81.2

Output difference between CCTs - 5%, CRIs - 15%.

ANGLE	0°	45°	90°
0°	2084	2084	2084
5°	2051	2054	2033
10°	1925	1936	1913
15°	1755	1754	1733
20°	1501	1463	1444
25°	1156	1099	1079
30°	834	794	777
35°	600	562	544
40°	378	329	316
45°	186	160	150
50°	87	74	70
55°	39	35	34
60°	19	17	17
65°	7	7	7
70°	4	4	4
75°	3	3	3
80°	2	2	2
85°	1	1	1
90°	0	0	0

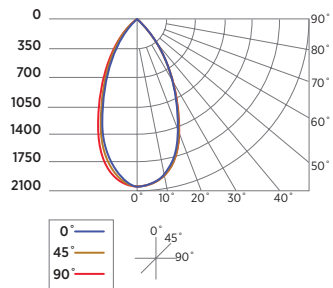
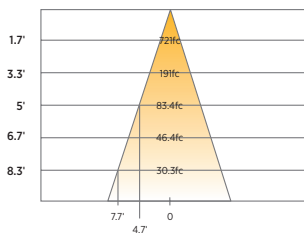

ELEMENT™ 3" CYLINDER

FIXED CYLINDER

PROJECT INFORMATION

JOB NAME AND INFORMATION

FIXTURE TYPE AND QUANTITY

NOTES

