

3" LED

ENTRA REMODEL ADJUSTABLE DOWNLIGHT & WALL WASH

ELEMENT
by Tech Lighting®

LED 5 YEAR WARRANTY

The ELEMENT Entra 3" remodel adjustable LED downlight offers a cost-effective alternative to meet residential and commercial specifications on budget-sensitive projects. Custom engineered for high performance and reliability, ELEMENT Entra is easy to configure with a complete feature set that offers flexibility without an overwhelming list of options. Entra LED modules are available in 4 color temperatures and include 20°, 40° and 65° interchangeable optics with hot-aiming (30° tilt; 359° rotation). Flanged or flangeless (includes mud plate), round or square, flat or beveled die-cast trims in Silver and a paintable White finish.

- Hot-aiming (30° tilt; 359° rotation)
- Flanged or Flangeless Ceiling Appearance
- 20°, 40° and 65° interchangeable optics (all included)
- Accepts 2 optical controls
- 3-step color binning

SPECIFICATIONS

| | 2700K | 3000K | 3500K | 4000K |
|--------------------|-------------------------------------------------------------------------------------------------------------------------------------------------------------------------|-------|-------|-------|
| DELIVERED LUMENS | 915 | 980 | 1004 | 1060 |
| WATTS | 12 | | | |
| EFFICACY | 76.3 | 81.7 | 83.7 | 88.3 |
| CRI | 90 | | | |
| CBCP (AT 3000K) | 20° - 4213; 40° - 1822; 65° - 691 | | | |
| CCT OPTIONS | 2700K, 3000K, 3500K, 4000K | | | |
| VOLTAGE | 120V or 277V | | | |
| DIMMING* | TRIAC, ELV or 0-10V (all standard) | | | |
| POWER SUPPLY | Constant current driver with +.9 power factor and >87% efficiency | | | |
| OPTICS | 20°, 40°, 65° (all included) | | | |
| ADJUSTABILITY | 0-30° tilt, 359° rotation | | | |
| CEILING APPEARANCE | Flanged or Flangeless. Includes two mounting collars: short collar accommodates 1/2" or 5/8" ceiling thickness; tall collar accommodates 3/4" and 1" ceiling thickness. | | | |
| CEILING APERTURE | 4" ceiling cut-out | | | |
| HOUSING | Non-IC | | | |
| CONSTRUCTION | Mechanism: Steel Trims: Die cast aluminum | | | |
| FINISH | Mechanism: Black powder coat Trims: Silver, White (paintable) | | | |
| GENERAL LISTING | ETL listed. Damp listed. Shower version wet listed. Energy Star. | | | |
| LED LIFETIME | L70; 50,000 hours | | | |
| WARRANTY** | 5 years | | | |



3" remodel adjustable

*See ELEMENT-lighting.com for dimmer compatibility.
**Visit ELEMENT-lighting.com for specific warranty limitations and details.
Accepts two optical controls and an optional trim-mounted lens.

3" LED

ENTRA REMODEL ADJUSTABLE DOWNLIGHT & WALL WASH

TRIMS

ROUND

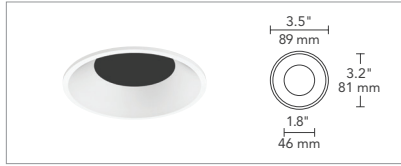

FLANGELESS BEVEL

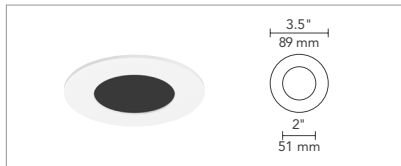

FLANGELESS FLAT

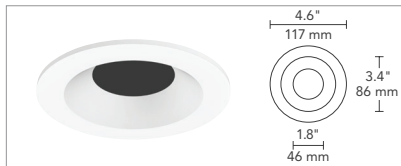

FLANGED BEVEL

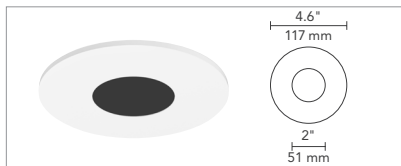

FLANGED FLAT

SQUARE

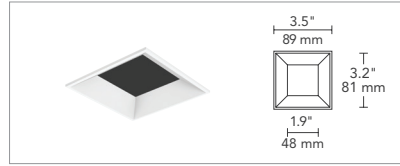

FLANGELESS BEVEL

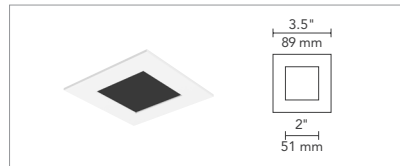

FLANGELESS FLAT

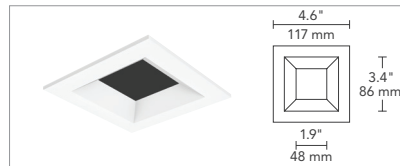

FLANGED BEVEL

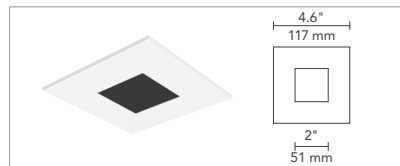

FLANGED FLAT

WALL WASH



FLANGELESS WALL WASH



FLANGED WALL WASH



FLANGELESS WALL WASH

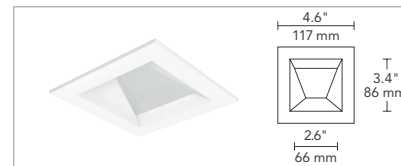

FLANGED WALL WASH

FINISH



SILVER



WHITE (PAINTABLE)

3" MECHANISM*

ROUND - SHOWN WITH SHORT COLLAR

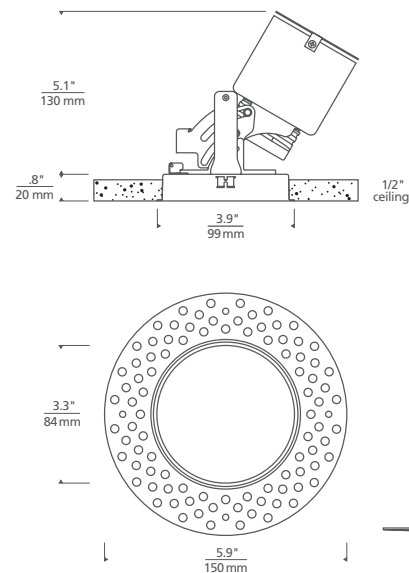

*SHIPS WITH MUD/PLASTER PLATE FOR FLANGELESS INSTALLATION

SQUARE - SHOWN WITH TALL COLLAR

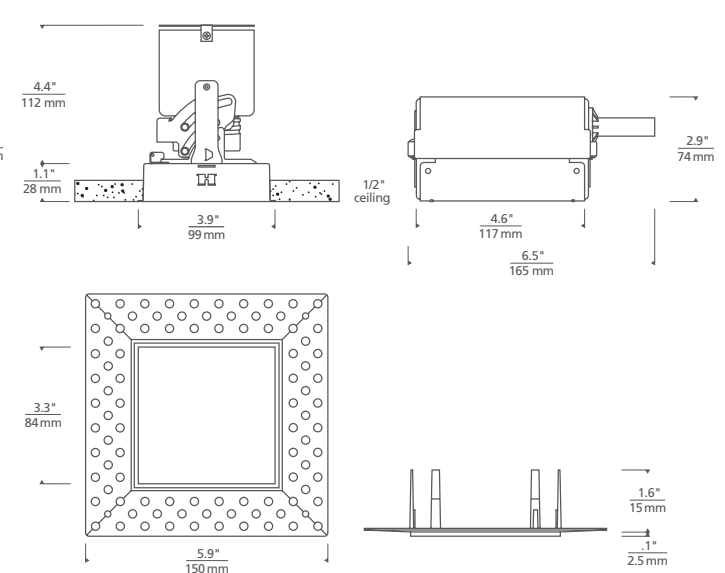

*SHIPS WITH MUD/PLASTER PLATE FOR FLANGELESS INSTALLATION

3" LED

ENTRA REMODEL ADJUSTABLE DOWNLIGHT & WALL WASH

GRIDS

HOUSING

| PRODUCT SERIES | LAMP | CRI | TEMPERATURE | BEAM | FUNCTION | HOUSING RATING | VOLTAGE |
|----------------|-------------------------|---------|-------------|----------|--------------------|----------------|------------------------|
| EN3RR | ENTRA 3" ROUND REMODEL | -LO LED | 9 90 CRI | 27 2700K | A 20° - 40° - 65°† | A ADJUSTABLE | N NON-IC |
| EN3SR | ENTRA 3" SQUARE REMODEL | | 30 3000K | | | | 120 VOLT (LEAVE BLANK) |
| | | | 35 3500K | | | | -277 277 VOLT |
| | | | 40 4000K | | | | |
| | -LO | 9 | | A | A | N | |

INCLUDES AN LED DRIVER THAT IS DIMMABLE BY TRIAC, ELV OR 0-10V CONTROLS.
 †LED MODULE SHIPS WITH 40° OPTIC INSTALLED. INCLUDES 20° AND 65° OPTICS AS WELL.
 HOUSING SHIPS WITH PLASTER-PLATE FOR USE ON FLANGELESS INSTALLATION, DO NOT USE PLATE FOR FLANGED INSTALLS.
 TRIMS ARE REQUIRED AND MUST BE ORDERED SEPARATELY.

TRIM

| PRODUCT SERIES | CEILING APPEARANCE | STYLE | APERTURE | FINISH | |
|----------------|--------------------|--------------|-------------------------|---------------------|----------|
| EN3R | ENTRA 3" ROUND | L FLANGELESS | B BEVEL | -O NO LENS | S SILVER |
| EN3S | ENTRA 3" SQUARE | F FLANGED | F FLAT | -H SHOWER (LENSED)* | W WHITE |
| | | W WALL WASH | -W WALL WASH (LENSED)** | | |

*SHOWER (LENSED) APERTURE (-H) REQUIRES BEVEL TRIM (B).
 **WALL WASH STYLE TRIM (W) REQUIRES WALL WASH LENSED APERTURE (-W).

PROJECT INFO

| FIXTURE TYPE & QUANTITY | JOB NAME & INFO | NOTES |
|-------------------------|-----------------|-------|
| | | |
| | | |

ELEMENT
by Tech Lighting[®]

GENERATION BRANDS
 7400 Linder Avenue, Skokie, Illinois 60077
 T 847.410.4400 F 847.410.4500



© 2017 Tech Lighting, L.L.C. All rights reserved. The "Tech Lighting" graphic is a registered trademark of Tech Lighting, L.L.C. Tech Lighting reserves the right to change specifications for product improvements without notification.

3" LED

ENTRA REMODEL ADJUSTABLE DOWNLIGHT & WALL WASH

PHOTOMETRICS: 3" ENTRA LED

DESCRIPTION: 3" LED Module
20° Beam - 0° Tilt, 3000K
MODEL: ENTRA Adjustable 20° High Output

INPUT POWER (WATTS): 11.9
INPUT POWER FACTOR: 0.98
ABSOLUTE LUMINOUS FLUX (LUMENS): 950*
LUMEN EFFICACY (LUMENS PER WATT): 80

| ANGLE | 0° | 45° | 90° |
|-------|------|------|------|
| 0° | 4213 | 4213 | 4213 |
| 5° | 3746 | 3797 | 3620 |
| 10° | 2524 | 2562 | 2359 |
| 15° | 1429 | 1454 | 1292 |
| 20° | 770 | 786 | 670 |
| 25° | 435 | 439 | 358 |
| 30° | 252 | 251 | 192 |
| 35° | 132 | 136 | 99 |
| 40° | 65 | 71 | 51 |
| 45° | 30 | 38 | 24 |
| 50° | 11 | 20 | 9 |
| 55° | 5 | 9 | 4 |
| 60° | 2 | 3 | 2 |
| 65° | 1 | 1 | 1 |
| 70° | 0 | 1 | 0 |
| 75° | 0 | 0 | 0 |
| 80° | 0 | 0 | 0 |
| 85° | 0 | 0 | 0 |
| 90° | 0 | 0 | 0 |

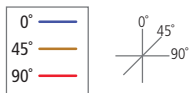
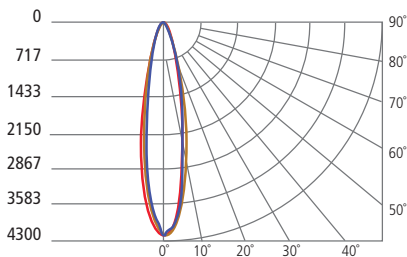
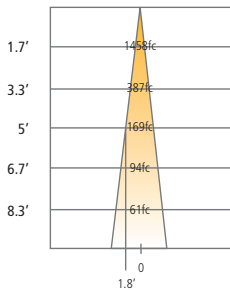

DESCRIPTION: 3" LED Module
40° Beam - 0° Tilt, 3000K
MODEL: ENTRA Adjustable 40° High Output

INPUT POWER (WATTS): 11.9
INPUT POWER FACTOR: 0.98
ABSOLUTE LUMINOUS FLUX (LUMENS): 979*
LUMEN EFFICACY (LUMENS PER WATT): 82

| ANGLE | 0° | 45° | 90° |
|-------|------|------|------|
| 0° | 1822 | 1822 | 1822 |
| 5° | 1771 | 1762 | 1770 |
| 10° | 1624 | 1614 | 1588 |
| 15° | 1413 | 1375 | 1289 |
| 20° | 1130 | 1050 | 916 |
| 25° | 795 | 700 | 562 |
| 30° | 486 | 422 | 323 |
| 35° | 267 | 242 | 175 |
| 40° | 120 | 131 | 81 |
| 45° | 49 | 65 | 33 |
| 50° | 21 | 29 | 14 |
| 55° | 10 | 10 | 7 |
| 60° | 3 | 4 | 2 |
| 65° | 0 | 2 | 0 |
| 70° | 0 | 0 | 0 |
| 75° | 0 | 0 | 0 |
| 80° | 0 | 0 | 0 |
| 85° | 0 | 0 | 0 |
| 90° | 0 | 0 | 0 |

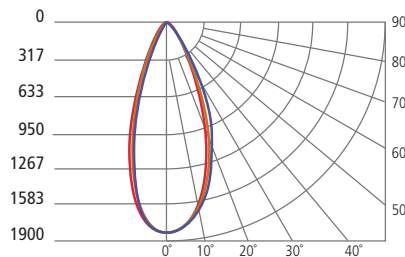
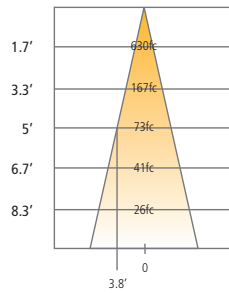

DESCRIPTION: 3" LED Module
65° Beam - 0° Tilt, 3000K
MODEL: ENTRA Adjustable 65° High Output

INPUT POWER (WATTS): 11.9
INPUT POWER FACTOR: 0.98
ABSOLUTE LUMINOUS FLUX (LUMENS): 1022*
LUMEN EFFICACY (LUMENS PER WATT): 86

| ANGLE | 0° | 45° | 90° |
|-------|-----|-----|-----|
| 0° | 691 | 691 | 691 |
| 5° | 701 | 691 | 680 |
| 10° | 703 | 696 | 677 |
| 15° | 708 | 707 | 686 |
| 20° | 698 | 706 | 683 |
| 25° | 658 | 667 | 647 |
| 30° | 568 | 580 | 563 |
| 35° | 436 | 449 | 436 |
| 40° | 275 | 296 | 285 |
| 45° | 145 | 161 | 150 |
| 50° | 68 | 72 | 67 |
| 55° | 28 | 30 | 28 |
| 60° | 3 | 13 | 5 |
| 65° | 0 | 3 | 0 |
| 70° | 0 | 0 | 0 |
| 75° | 0 | 0 | 0 |
| 80° | 0 | 0 | 0 |
| 85° | 0 | 0 | 0 |
| 90° | 0 | 0 | 0 |

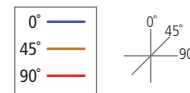
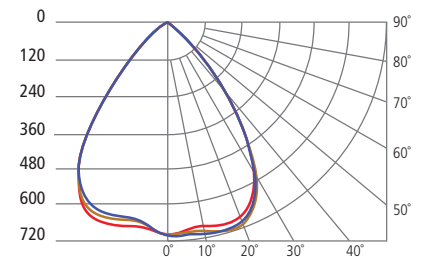
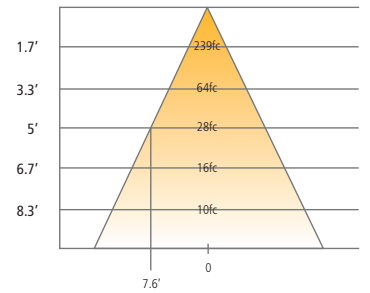

*For 80 CRI values, multiply by 1.25.