

3" LED

ENTRA REMODEL ADJUSTABLE DOWNLIGHT & WALL WASH

ELEMENT
by Tech Lighting®

LED 5 YEAR WARRANTY

The ELEMENT Entra 3" remodel adjustable LED downlight offers a cost-effective alternative to meet residential and commercial specifications on budget-sensitive projects. Custom engineered for high performance and reliability, ELEMENT Entra is easy to configure with a complete feature set that offers flexibility without an overwhelming list of options. Entra LED modules are available in 4 color temperatures and include 20°, 40° and 65° interchangeable optics with hot-aiming (30° tilt; 359° rotation). Flanged or flangeless (includes mud plate), round or square, flat or beveled die-cast trims in Silver and a paintable White finish.

- Hot-aiming (30° tilt; 359° rotation)
- Flanged or Flangeless Ceiling Appearance
- 20°, 40° and 65° interchangeable optics (all included)
- Accepts 2 optical controls
- 3-step color binning

SPECIFICATIONS

	2700K	3000K	3500K	4000K
DELIVERED LUMENS	915	980	1004	1060
WATTS	12			
EFFICACY	76.3	81.7	83.7	88.3
CRI	90			
CBCP (AT 3000K)	20° - 4213; 40° - 1822; 65° - 691			
CCT OPTIONS	2700K, 3000K, 3500K, 4000K			
VOLTAGE	120V or 277V			
DIMMING*	TRIAC, ELV or 0-10V (all standard)			
POWER SUPPLY	Constant current driver with +.9 power factor and >87% efficiency			
OPTICS	20°, 40°, 65° (all included)			
ADJUSTABILITY	0-30° tilt, 359° rotation			
CEILING APPEARANCE	Flanged or Flangeless. Includes two mounting collars: short collar accommodates 1/2" or 5/8" ceiling thickness; tall collar accommodates 3/4" and 1" ceiling thickness.			
CEILING APERTURE	4" ceiling cut-out			
HOUSING	Non-IC			
CONSTRUCTION	Mechanism: Steel Trims: Die cast aluminum			
FINISH	Mechanism: Black powder coat Trims: Silver, White (paintable)			
GENERAL LISTING	ETL listed. Damp listed. Shower version wet listed. Energy Star.			
LED LIFETIME	L70; 50,000 hours			
WARRANTY**	5 years			



3" remodel adjustable

*See ELEMENT-lighting.com for dimmer compatibility.
**Visit ELEMENT-lighting.com for specific warranty limitations and details.
Accepts two optical controls and an optional trim-mounted lens.

3" LED

ENTRA REMODEL ADJUSTABLE DOWNLIGHT & WALL WASH

TRIMS

ROUND

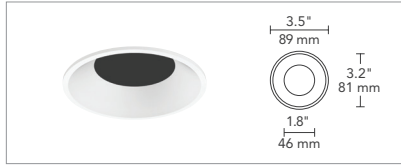

FLANGELESS BEVEL

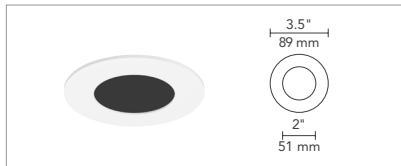

FLANGELESS FLAT

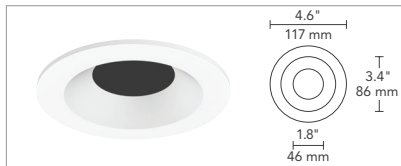

FLANGED BEVEL

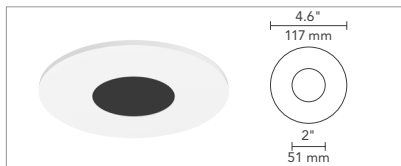

FLANGED FLAT

SQUARE

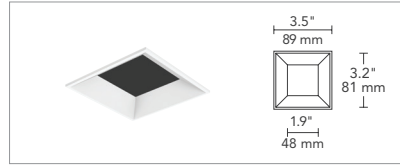

FLANGELESS BEVEL

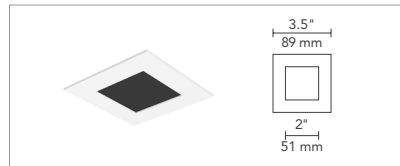

FLANGELESS FLAT

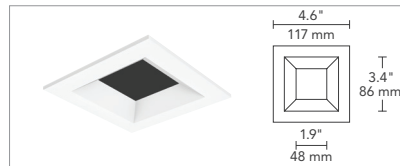

FLANGED BEVEL

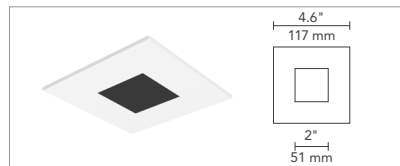

FLANGED FLAT

WALL WASH



FLANGELESS WALL WASH



FLANGED WALL WASH



FLANGELESS WALL WASH

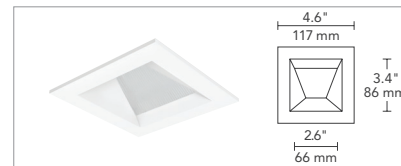

FLANGED WALL WASH

FINISH



SILVER



WHITE (PAINTABLE)

3" MECHANISM*

ROUND - SHOWN WITH SHORT COLLAR

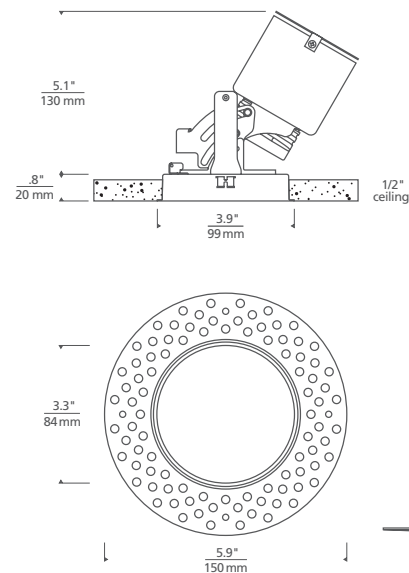

*SHIPS WITH MUD/PLASTER PLATE FOR FLANGELESS INSTALLATION

SQUARE - SHOWN WITH TALL COLLAR

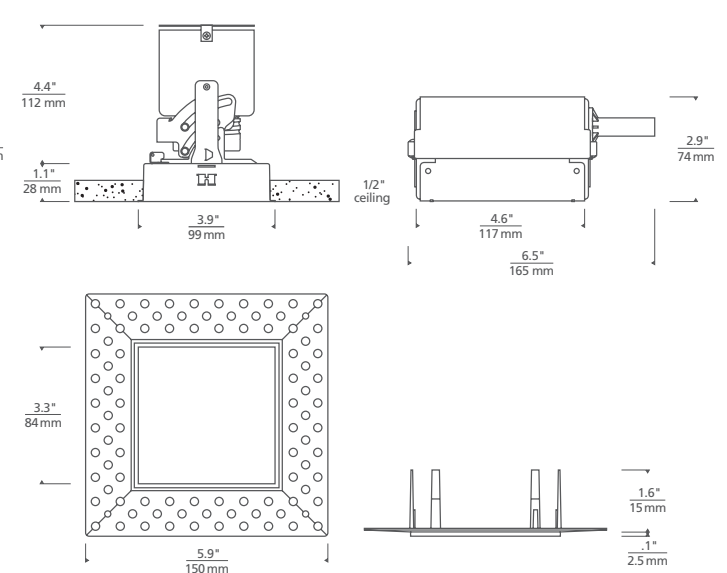

*SHIPS WITH MUD/PLASTER PLATE FOR FLANGELESS INSTALLATION

3" LED

ENTRA REMODEL ADJUSTABLE DOWNLIGHT & WALL WASH

GRIDS

HOUSING

PRODUCT SERIES	LAMP	CRI	TEMPERATURE	BEAM	FUNCTION	HOUSING RATING	VOLTAGE	
EN3RR	ENTRA 3" ROUND REMODEL	-LO LED	9 90 CRI	27 2700K	A 20° - 40° - 65°†	A ADJUSTABLE*	N NON-IC	120 VOLT (LEAVE BLANK)
EN3SR	ENTRA 3" SQUARE REMODEL		30 3000K					-277 277 VOLT
			35 3500K					
			40 4000K					
	-LO	9		A	A	N		

INCLUDES AN LED DRIVER THAT IS DIMMABLE BY TRIAC, ELV OR 0-10V CONTROLS.
 *ADJUST TO 30° TILT FOR WALL WASH APPLICATION.
 †LED MODULE SHIPS WITH 40° OPTIC INSTALLED. INCLUDES 20° AND 65° OPTICS AS WELL.
 HOUSING SHIPS WITH PLASTER-PLATE FOR USE ON FLANGELESS INSTALLATION, DO NOT USE PLATE FOR FLANGED INSTALLS.
 TRIMS ARE REQUIRED AND MUST BE ORDERED SEPARATELY.

TRIM

PRODUCT SERIES	CEILING APPEARANCE	STYLE	APERTURE	FINISH	
EN3R	ENTRA 3" ROUND	L FLANGELESS	B BEVEL	-O NO LENS	S SILVER
EN3S	ENTRA 3" SQUARE	F FLANGED	F FLAT	-H SHOWER (LENSED)*	W WHITE
		W WALL WASH	-W WALL WASH (LENSED)**		

*SHOWER (LENSED) APERTURE (-H) REQUIRES BEVEL TRIM (B).
 **WALL WASH STYLE TRIM (W) CAN ONLY BE USED WITH WALL WASH LENSED APERTURE (-W).

PROJECT INFO

FIXTURE TYPE & QUANTITY	JOB NAME & INFO	NOTES

ELEMENT
by Tech Lighting[®]

GENERATION BRANDS
7400 Linder Avenue, Skokie, Illinois 60077
T 847.410.4400 F 847.410.4500

3" LED

ENTRA REMODEL ADJUSTABLE DOWNLIGHT & WALL WASH

PHOTOMETRICS: 3" ENTRA LED

DESCRIPTION: 3" LED Module
20° Beam - 0° Tilt, 3000K
MODEL: ENTRA Adjustable 20° High Output

INPUT POWER (WATTS): 11.9
INPUT POWER FACTOR: 0.98
ABSOLUTE LUMINOUS FLUX (LUMENS): 950*
LUMEN EFFICACY (LUMENS PER WATT): 80

ANGLE	0°	45°	90°
0°	4213	4213	4213
5°	3746	3797	3620
10°	2524	2562	2359
15°	1429	1454	1292
20°	770	786	670
25°	435	439	358
30°	252	251	192
35°	132	136	99
40°	65	71	51
45°	30	38	24
50°	11	20	9
55°	5	9	4
60°	2	3	2
65°	1	1	1
70°	0	1	0
75°	0	0	0
80°	0	0	0
85°	0	0	0
90°	0	0	0

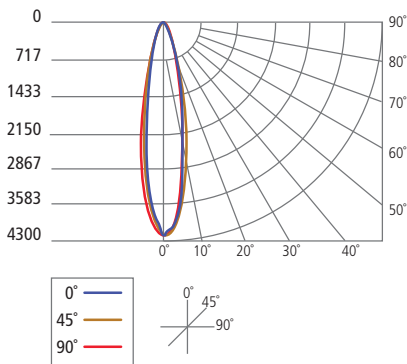
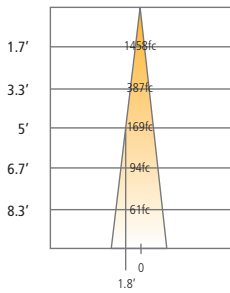

DESCRIPTION: 3" LED Module
40° Beam - 0° Tilt, 3000K
MODEL: ENTRA Adjustable 40° High Output

INPUT POWER (WATTS): 11.9
INPUT POWER FACTOR: 0.98
ABSOLUTE LUMINOUS FLUX (LUMENS): 979*
LUMEN EFFICACY (LUMENS PER WATT): 82

ANGLE	0°	45°	90°
0°	1822	1822	1822
5°	1771	1762	1770
10°	1624	1614	1588
15°	1413	1375	1289
20°	1130	1050	916
25°	795	700	562
30°	486	422	323
35°	267	242	175
40°	120	131	81
45°	49	65	33
50°	21	29	14
55°	10	10	7
60°	3	4	2
65°	0	2	0
70°	0	0	0
75°	0	0	0
80°	0	0	0
85°	0	0	0
90°	0	0	0

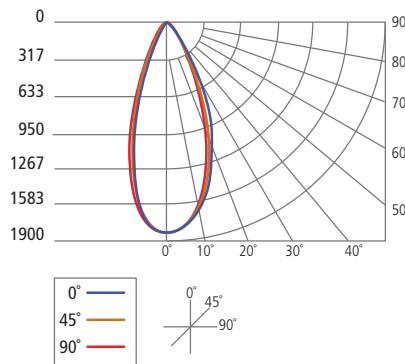
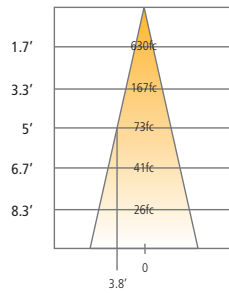

DESCRIPTION: 3" LED Module
65° Beam - 0° Tilt, 3000K
MODEL: ENTRA Adjustable 65° High Output

INPUT POWER (WATTS): 11.9
INPUT POWER FACTOR: 0.98
ABSOLUTE LUMINOUS FLUX (LUMENS): 1022*
LUMEN EFFICACY (LUMENS PER WATT): 86

ANGLE	0°	45°	90°
0°	691	691	691
5°	701	691	680
10°	703	696	677
15°	708	707	686
20°	698	706	683
25°	658	667	647
30°	568	580	563
35°	436	449	436
40°	275	296	285
45°	145	161	150
50°	68	72	67
55°	28	30	28
60°	3	13	5
65°	0	3	0
70°	0	0	0
75°	0	0	0
80°	0	0	0
85°	0	0	0
90°	0	0	0

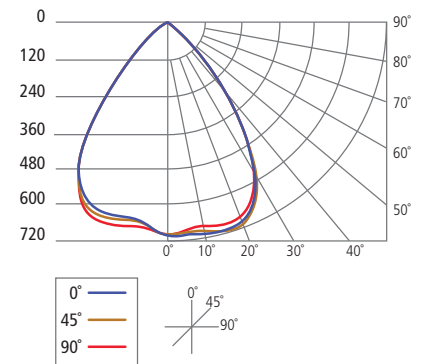
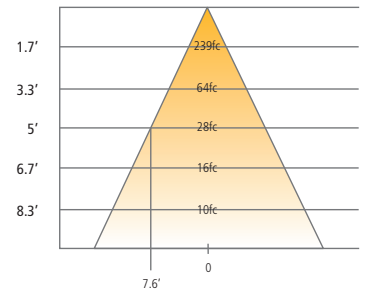

*For 80 CRI values, multiply by 1.25.

GENERATION BRANDS