

# ELEMENT™ 4" PRO SERIES LED

## ADJUSTABLE DOWNLIGHT

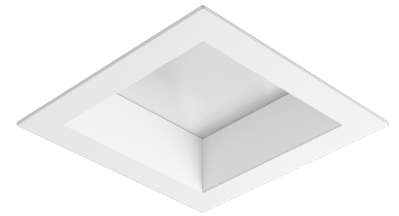

SHOWN IN FLANGED BEVEL SQUARE

The Element 4" Pro Series Adjustable Downlight features full adjustability with lockable, tool-free hot aiming, including patented high/low lamp positioning. Engineered with a precision diffuser and Solite Soft Focus lens that eliminates hot spots, direct visibility into the housing, and delivers a clean aperture and ceiling aesthetic. Complementing the Element 4" Pro Series Fixed downlight, the Adjustable is offered in a variety of options, including output, beam spreads and the choice of Static White, Warm Dim or Tunable White to complete any commercial installation.

- 2-step standard
- Solite Soft Focus Lens plus diffuser standard
- Tool-free aiming/locking: 0-40° tilt, 361° rotation
- Patented high/low lamp positioning
- Lutron/eldoLED options

### LUMEN MULTIPLIER (CRI/CCT)

CCT	80 CRI MULTIPLIER	90 CRI MULTIPLIER
2700K	0.95	0.80
3000K	1.00	0.85
3500K	1.05	0.90

Lumen output will vary by CCT and CRI. See photometric charts for output information.

### SPECIFICATIONS

WATTAGE	STATIC WHITE		WARM DIM		TUNABLE WHITE	
	Lumens	Efficacy	Lumens	Efficacy	Lumens	Efficacy
8W	675	84	551	70	464	58
12W	990	83	826	70	697	58
17W	1350	79	1170	69	987	58
24W	1800	75	1569	65	1393	58
29W	2430	84	2137	69	1800	62
36W	2880	80	NA		NA	
CRI	80+, 90+		90+		90+	
CCT OPTIONS	2700K, 3000K, 3500K or 4000K		3000K - 1800K		4000K - 1800K or 5000K - 2700K	
COLOR CONSISTENCY	2-step		3-step		2-step	
VOLTAGE	120V or 277V					
DIMMING <sup>1</sup>	Standard phase dimming (down to 5%)   0-10V (down to 5%) Lutron Hi-lume EcoSystem (down to 0.1%) Lutron Hi-lume 2-wire (down to 1%) EldoLED 0-10V or Dali (down to 0.1%)				EldoLED 0-10V or Dali (down to 0.1%)	
POWER SUPPLY	Constant current driver with ±9 power factor and +80% efficiency					
BEAM SPREAD	18°, 25°, 40°, 60°					
ADJUSTABILITY	0-40° tilt, 361° rotation, high/low lamp positioning, 45° collar rotation					
CEILING APPEARANCE	Flanged, Flangeless, Flangeless in Wood Ceiling					
CEILING THICKNESS	Flanged: Up to 2-1/2" Flangeless: No ceiling thickness limitations Flangeless in Wood Ceiling: No ceiling thickness limitations Note: Thicker ceilings impact light cut off					
CEILING APERTURE	4-1/2" ceiling cutout					
HOUSING	IC Airtight, Non-IC Airtight, Chicago Plenum, IC suitable up to R60 spray foam insulation					
CONSTRUCTION	Housing: Heavy-Gauge, Cold-Rolled Steel Trims: Die-Cast Aluminum					
FINISH	Housing: Black Powder Coat Trim: Select finish options for Bevel and Flange separately: White, Black, Haze Silver					
GENERAL LISTING	ETL Listed. Damp Listed.					
CALIFORNIA TITLE 24	Registered CEC Appliance Database. Can be used to comply with CEC 2019 Title 24 part 6 (JA8-2016, JA8-2019) (for 90 CRI versions).					
L70	50,000 hours min					
WARRANTY <sup>2</sup>	5 years					

Data in chart reflects 3000K/80CRI values unless noted. Lumen values are delivered lumens, not source lumens. Custom Output/Custom RAL/Custom CCT available, Contact Quotes Department.

Ordering grids available on page 2.

<sup>1</sup>See ELEMENT-Lighting.com for dimmer compatibility.

<sup>2</sup>visit ELEMENT-lighting.com for specific warranty limitations and details.

# ELEMENT™ 4" PRO SERIES LED

## ADJUSTABLE DOWNLIGHT

ORDERING GRIDS

HOUSING

PRODUCT	CEILING APPEARANCE	OUTPUT	CRI/CCT	BEAM SPREAD	FUNCTION	HOUSING RATING	DRIVER	VOLTAGE
<b>E4PR</b> ELEMENT 4" PRO SERIES ROUND	<b>L</b> FLANGELESS	<b>-L08</b> 8W (675 LMS) <sup>2</sup>	<b>830</b> 80 CRI, 3000K, 2-STEP	<b>1</b> 18°	<b>A</b> ADJUSTABLE	<b>I</b> IC AIRTIGHT	STANDARD PHASE 5% (LEAVE BLANK)	120 VOLT (LEAVE BLANK)
<b>E4PS</b> ELEMENT 4" PRO SERIES SQUARE	<b>F</b> FLANGED	<b>-L12</b> 12W (990 LMS)	<b>835</b> 80 CRI, 3500K, 2-STEP	<b>2</b> 25°		<b>N</b> NON-IC AIRTIGHT	0-10V DIMMING 5%	-2 277 VOLT
	<b>WC</b> WOOD CEILING <sup>1</sup>	<b>-L17</b> 17W (1350 LMS)	<b>840</b> 80 CRI, 4000K, 2-STEP	<b>4</b> 40°		<b>C</b> CHICAGO PLENUM	ELDOLED 0.1%	
		<b>-L24</b> 24W (1800 LMS)	<b>927</b> 90 CRI, 2700K, 2-STEP	<b>6</b> 60°		<b>E</b> EMERGENCY BATTERY BACKUP (NON-IC AIRTIGHT/CHICAGO PLENUM) <sup>7</sup>	ELDOLED 0.1% 0-10V LOGARITHMIC	
		<b>-L29</b> 29W (2430 LMS)	<b>930</b> 90 CRI, 3000K, 2-STEP				ELDOLED 1% 0-10V LINEAR	
		<b>-L36</b> 36W (2880 LMS) <sup>3</sup>	<b>935</b> 90 CRI, 3500K, 2-STEP				ELDOLED 1% 0-10V LOGARITHMIC	
			<b>940</b> 90 CRI, 4000K, 2-STEP				ELDOLED 0.1% DALI	
			<b>WD31</b> 90 CRI, 3000K-1800K, WARM DIM, 3-STEP				ELDOLED TUNABLE WHITE 0.1% 0-10V LINEAR <sup>6</sup>	
			<b>TW52</b> 90 CRI, 5000K-2700K, TUNABLE WHITE, 2-STEP <sup>6</sup>				ELDOLED TUNABLE WHITE 0.1% DALI <sup>6</sup>	
			<b>TW41</b> 90 CRI, 4000K-1800K, TUNABLE WHITE, 2-STEP <sup>6</sup>				LUTRON HI-LUME 1% 2-WIRE <sup>4</sup>	
							LUTRON HI-LUME 0.1% ECOSYSTEM <sup>5</sup>	

Trims are required and must be ordered separately.

Output lists nominal wattage and lumens at 3000K/80CRI, actual wattage and lumens may vary slightly.

<sup>1</sup>WC - Wood Ceiling accommodates Flangeless trims only. For Flanged trims in a wood ceiling use standard Flanged housing.

<sup>2</sup>L08 - Output min standard phase dimming level may be 5% or greater.

<sup>3</sup>L36 - Output available Non-IC/CP only. Not available with -HL2W and -HLECO drivers. Not available with WD31 Warm Dim or TW52/TW41 Tunable White.

<sup>4</sup>HL2W - Lutron 2-wire low-voltage electronic dimming, 120V only. Available IC only for L08, L12, and L17 output. Not available with WD31 Warm Dim for L08 output.

<sup>5</sup>HLECO - Lutron EcoSystem available IC only for L08, L12, and L17 output. Available with WD31 Warm Dim only for L12 and L17 output. Not available for L36 output.

<sup>6</sup>TW52/TW41 - Tunable White available with -ELTO (0-10V, linear) or -ELTD (DALI) only. For 0-10V logarithmic dimming consult Quotes Department.

<sup>7</sup>E - Emergency Battery Backup Housing available in E4NGEMH Housing only.

TRIM

PRODUCT	CEILING APPEARANCE	STYLE	FUNCTION	BEVEL FINISH	FLANGE FINISH
<b>E4PR</b> ELEMENT 4" PRO SERIES ROUND	<b>L</b> FLANGELESS	<b>R</b> REGRESS (1.0")	<b>A</b> ADJUSTABLE	<b>-W</b> WHITE	FLANGELESS ONLY
<b>E4PS</b> ELEMENT 4" PRO SERIES SQUARE	<b>F</b> FLANGED			<b>-B</b> BLACK	(LEAVE BLANK)
	<b>F15</b> FLANGED 1.1"-1.5" CEILING THICKNESS			<b>-HS</b> HAZE SILVER	<b>W</b> WHITE
	<b>F20</b> FLANGED 1.6"-2.0" CEILING THICKNESS				<b>B</b> BLACK
	<b>F25</b> FLANGED 2.1"-2.5" CEILING THICKNESS				

TRIM

PRODUCT	BEAM SPREAD
<b>353E4LEDCOPT</b>	<b>18</b> 18°
	<b>25</b> 25°
	<b>40</b> 40°
	<b>60</b> 60°

**353E4LEDCOPT**

# ELEMENT™ 4" PRO SERIES LED

## ADJUSTABLE DOWNLIGHT

TRIMS

ROUND

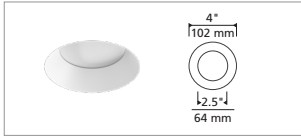

FLANGELESS

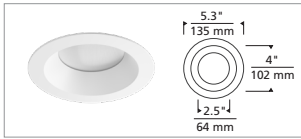

FLANGED

SQUARE

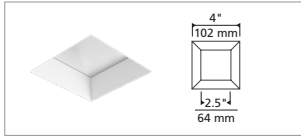

FLANGELESS

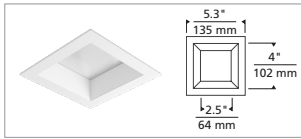

FLANGED

FINISH OPTIONS

NO FLANGE



HAZE SILVER BEVEL

WHITE FLANGE

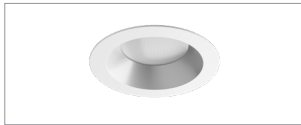

WHITE FLANGE, HAZE SILVER BEVEL

BLACK FLANGE

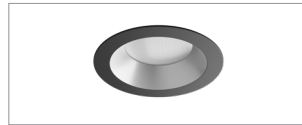

BLACK FLANGE, HAZE SILVER BEVEL

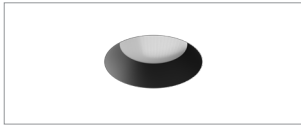

BLACK BEVEL

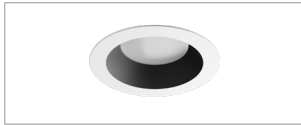

WHITE FLANGE, BLACK BEVEL

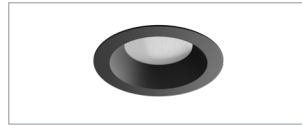

BLACK FLANGE, BLACK BEVEL



WHITE BEVEL



WHITE FLANGE, WHITE BEVEL

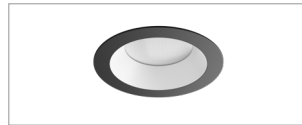

BLACK FLANGE, WHITE BEVEL

HOUSINGS

E4NGH

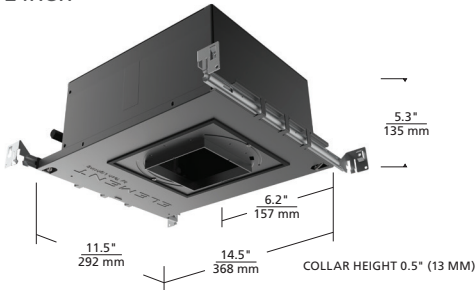

IC AIRTIGHT / NON-IC AIRTIGHT / CHICAGO PLENUM

E4NGEMH

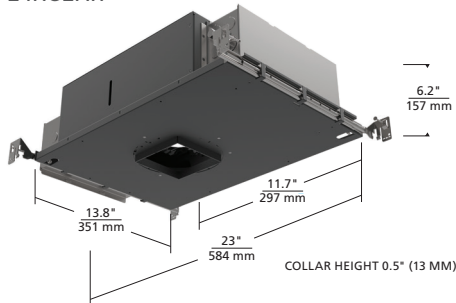

EMERGENCY BATTERY BACKUP  
(NON-IC / CHICAGO PLENUM)

