

ELEMENT™ 4" PRO SERIES LED

ADJUSTABLE DOWNLIGHT

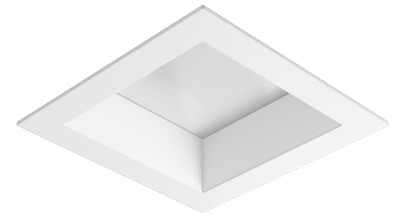

SHOWN IN FLANGED BEVEL SQUARE

The Element 4" Pro Series Adjustable Downlight features full adjustability with lockable, tool-free hot aiming, including patented high/low lamp positioning. Engineered with a precision diffuser and Solite Soft Focus lens that eliminates hot spots, direct visibility into the housing, and delivers a clean aperture and ceiling aesthetic. Complementing the Element 4" Pro Series Fixed downlight, the Adjustable is offered in a variety of options, including output, beam spreads and the choice of Static White, Warm Dim or Tunable White to complete any commercial installation.

- 2-step standard
- Solite Soft Focus Lens plus diffuser standard
- Tool-free aiming/locking: 0-40° tilt, 361° rotation
- Patented high/low lamp positioning
- Lutron/eldoLED options

LUMEN MULTIPLIER (CRI/CCT)

CCT	80 CRI MULTIPLIER	90 CRI MULTIPLIER
2700K	0.95	0.80
3000K	1.00	0.85
3500K	1.05	0.90

Lumen output will vary by CCT and CRI. See photometric charts for output information.

SPECIFICATIONS

WATTAGE	STATIC WHITE		WARM DIM		TUNABLE WHITE	
	Lumens	Efficacy	Lumens	Efficacy	Lumens	Efficacy
8W	675	84	551	70	464	58
12W	990	83	826	70	697	58
17W	1350	79	1170	69	987	58
24W	1800	75	1569	65	1393	58
29W	2430	84	2137	69	1800	62
36W	2880	80	NA		NA	
CRI	80+, 90+		90+		90+	
CCT	2700K, 3000K, 3500K, or 4000K		3000K - 1800K		4000K - 1800K or 5000K - 2700K	
COLOR CONSISTENCY	2-step		3-step		2-step	
VOLTAGE	120V or 277V					
DIMMING ¹	Standard reverse-phase, forward-phase, TRIAC, and 0-10V dimming (down to 1% or 5%+ depending on wattage) Lutron Hi-lume EcoSystem (down to 0.1%) Lutron Hi-lume 2-wire (down to 1%) EldoLED 0-10V or Dali (down to 0.1%)				EldoLED 0-10V or Dali (down to 0.1%)	
POWER SUPPLY	Constant current driver with +.9 power factor and +80% efficiency					
BEAM SPREAD	18°, 25°, 40°, or 60°					
ADJUSTABILITY	0-40° tilt, 361° rotation, high/low lamp positioning, 45° collar rotation					
CEILING APPEARANCE	Flanged, Flangeless, Flangeless in Wood Ceiling					
CEILING THICKNESS	Flanged: Up to 2-1/2" Flangeless: No ceiling thickness limitations Flangeless in Wood Ceiling: No ceiling thickness limitations Note: Thicker ceilings impact light cut off					
CEILING APERTURE	4-1/2" ceiling cutout					
HOUSING	IC Airtight, Non-IC Airtight, Chicago Plenum, IC suitable up to R60 spray foam insulation					
CONSTRUCTION	Housing: Heavy-Gauge, Cold-Rolled Steel Trims: Die-Cast Aluminum					
FINISH	Housing: Black Powder Coat Trim: Select finish options for Bevel and Flange separately: White, Black, Haze Silver					
GENERAL LISTINGS	ETL Listed. Damp Listed.					
CALIFORNIA TITLE 24	Registered CEC Appliance Database. Can be used to comply with CEC 2019 Title 24 Part 6 (JA8-2016, JA8-2019) (for 90 CRI versions).					
L70	50,000 hours min					
WARRANTY ²	5 years					

Data in chart reflects 3000K/80CRI values unless noted. Lumen values are delivered lumens, not source lumens. Custom Output/Custom RAL/Custom CCT available, Contact Quotes Department.

Ordering grids available on page 2.

¹See ELEMENT-Lighting.com for dimmer compatibility.

²Visit ELEMENT-Lighting.com for specific warranty limitations and details.

ELEMENT™ 4" PRO SERIES LED

ADJUSTABLE DOWNLIGHT

ORDERING GRIDS

HOUSING

PRODUCT	CEILING APPEARANCE	OUTPUT	CRI/CCT	BEAM SPREAD	FUNCTION	HOUSING RATING	DRIVER	VOLTAGE
E4PR ELEMENT 4" PRO SERIES ROUND	L FLANGELESS	-L08 8W (675 LMS) ²	830 80 CRI, 3000K, 2-STEP	1 18°	A ADJUSTABLE	I IC AIRTIGHT	INTEGRATED DRIVERS 120V/277V	120 VOLT (LEAVE BLANK)
	F FLANGED		835 80 CRI, 3500K, 2-STEP	2 25°		N NON-IC AIRTIGHT	UNIVERSAL PHASE/0-10V 1-5% (LEAVE BLANK) ⁶	-2 277 VOLT
E4PS ELEMENT 4" PRO SERIES SQUARE	WC WOOD CEILING ¹	-L12 12W (990 LMS)	840 80 CRI, 4000K, 2-STEP	4 40°		C CHICAGO PLENUM		
		-L17 17W (1350 LMS)	927 90 CRI, 2700K, 2-STEP	6 60°		E EMERGENCY BATTERY BACKUP (NON-IC AIRTIGHT/CHICAGO PLENUM) ⁵	-ELDO ELDOLED 0.1% 0-10V LINEAR	
		-L24 24W (1800 LMS)	930 90 CRI, 3000K, 2-STEP				-ELDOA ELDOLED 0.1% 0-10V LOGARITHMIC	
		-L29 29W (2430 LMS)	935 90 CRI, 3500K, 2-STEP				-ELDD ELDOLED 0.1% DALI	
		-L36 36W (2880 LMS) ³	940 90 CRI, 4000K, 2-STEP				-ELTO ELDOLED TUNABLE WHITE 0.1% 0-10V LINEAR ⁴	
			WD31 90 CRI, 3000K-1800K, WARM DIM, 3-STEP				-ELTD ELDOLED TUNABLE WHITE 0.1% DALI ⁴	
			TW52 90 CRI, 5000K-2700K, TUNABLE WHITE, 2-STEP ⁴				-HLECO LUTRON HI-LUME 0.1% ECOSYSTEM ^{7,8}	
			TW41 90 CRI, 4000K-1800K, TUNABLE WHITE, 2-STEP ⁴					
							INTEGRATED DRIVERS 120V	
							-HL2W LUTRON HI-LUME 1% 2-WIRE ⁹	

Trims are required and must be ordered separately.

Output lists nominal wattage and lumens at 3000K/80CRI, actual wattage and lumens may vary slightly.

¹WC - Wood Ceiling accommodates Flangeless trims only. For Flanged trims in a wood ceiling use standard Flanged housing.

²L08 - Dimming performance with standard UNIVERSAL PHASE/0-10V driver varies dramatically from <1% to >10% depending on the dimmer; please refer to Dimmer Compatibility chart.

³L36 - Output available Non-IC/CP only. Not available with HL2W and HLECO drivers. Not available with WD31 Warm Dim or TW52/TW41 Tunable White.

⁴TW52/TW41 - Tunable White available with ELTO (0-10V, linear) or ELTD (DALI) only. For 0-10V logarithmic dimming consult Quotes Department.

⁵E - Emergency Battery Backup Housing available in E4NGEMH Housing only.

⁶Universal dimming is reverse-phase, forward-phase, and TRIAC. The standard UNIVERSAL PHASE/0-10V driver dims to 1% with L12 and L17, and to 5% with L08, L24, L29 and L36. Dimming performance varies by dimmer; please refer to Dimmer Compatibility chart.

⁷HLECO - Lutron EcoSystem available IC only for L08, L12, and L17 output. Available with WD31 Warm Dim only for L12 and L17 output. Not available for L36 output.

⁸HLECO - Lutron has put their entire 0.1% ECO drivers on indefinite hold which impacts all -HLECO item numbers. Please consult factory for alternatives. This does not impact -HL2W.

⁹HL2W - Available IC only for L08, L12, and L17 output. Not available with WD31 Warm Dim for L08 output.

TRIM

PRODUCT	CEILING APPEARANCE	STYLE	FUNCTION	BEVEL FINISH	FLANGE FINISH
E4PR ELEMENT 4" PRO SERIES ROUND	L FLANGELESS	R REGRESS (1.0")	A ADJUSTABLE	-W WHITE	FLANGELESS ONLY (LEAVE BLANK)
	F FLANGED			-B BLACK	
E4PS ELEMENT 4" PRO SERIES SQUARE	F15 FLANGED 1.1"-1.5" CEILING THICKNESS			-HS HAZE SILVER	W WHITE
	F20 FLANGED 1.6"-2.0" CEILING THICKNESS				B BLACK
	F25 FLANGED 2.1"-2.5" CEILING THICKNESS				
		R	A	-	

REPLACEMENT OPTICS

PRODUCT	BEAM SPREAD
353E4LEDCOPT	18 18°
	25 25°
	40 40°
	60 60°
353E4LEDCOPT	

ELEMENT™ 4" PRO SERIES LED

ADJUSTABLE DOWNLIGHT

TRIMS

ROUND

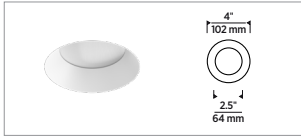

FLANGELESS

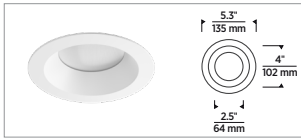

FLANGED

SQUARE

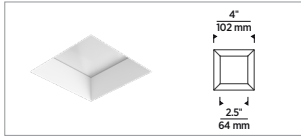

FLANGELESS

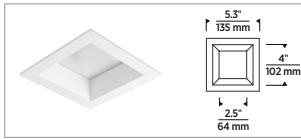

FLANGED

FINISH OPTIONS

NO FLANGE



HAZE SILVER BEVEL

WHITE FLANGE



WHITE FLANGE, HAZE SILVER BEVEL

BLACK FLANGE

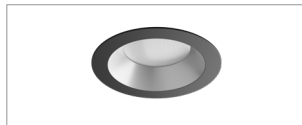

BLACK FLANGE, HAZE SILVER BEVEL

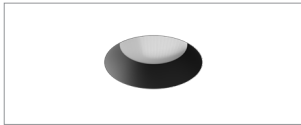

BLACK BEVEL

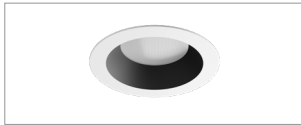

WHITE FLANGE, BLACK BEVEL

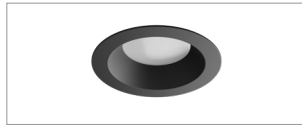

BLACK FLANGE, BLACK BEVEL



WHITE BEVEL



WHITE FLANGE, WHITE BEVEL

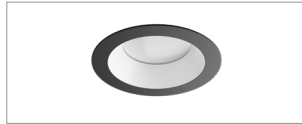

BLACK FLANGE, WHITE BEVEL

HOUSINGS

E4NGH

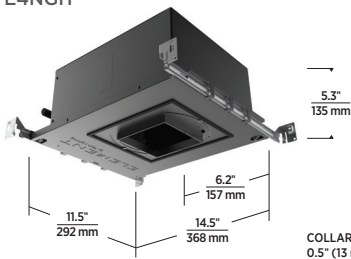

COLLAR HEIGHT:
0.5" (13 mm)

IC AIRTIGHT / NON-IC AIRTIGHT / CHICAGO PLENUM

E4NGEMH

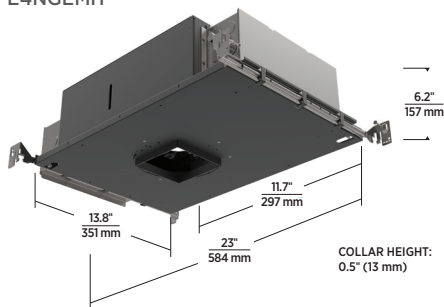

COLLAR HEIGHT:
0.5" (13 mm)

EMERGENCY BATTERY BACKUP
(NON-IC / CHICAGO PLENUM)

ELEMENT™ 4" PRO SERIES LED

ADJUSTABLE DOWNLIGHT

PROJECT INFORMATION

JOB NAME AND INFORMATION

FIXTURE TYPE AND QUANTITY

NOTES
