

ELEMENT™ 4" PRO SERIES LED

WALL WASH DOWNLIGHT

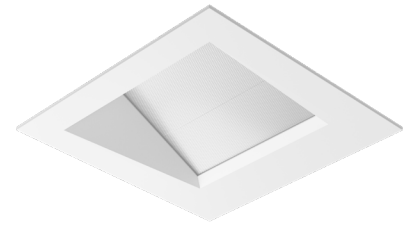

SHOWN IN FLANGED WALL WASH SQUARE

The Element 4" Pro Series Wall Wash sets a new standard for best-in-class performance. Creating a beautifully uniform high output flood of light without scalloping or hot spots. With even illumination from top to bottom of the wall, the Element 4" Pro Series Wall Wash complements the Element 4" Pro Series Fixed and Adjustable downlights for any commercial space and is available in a variety of options, including output and the choice of Static White, Warm Dim or Tunable White.

- Luminaires turning film, two directions
- Even vertical and horizontal illumination of wall
- High efficacy output: >76 lumens per watt (static white)
- 2-step standard
- Standard Triac/ELV dimming down to 1%
- Lutron/eldoLED options

LUMEN MULTIPLIER (CRI/CCT)

CCT	80 CRI MULTIPLIER	90 CRI MULTIPLIER
2700K	0.95	0.80
3000K	1.00	0.85
3500K	1.05	0.90

Lumen output will vary by CCT and CRI. See photometric charts for output information.

SPECIFICATIONS

		STATIC WHITE		WARM DIM		TUNABLE WHITE	
HOUSING (RATING)	Wattage	Lumens	Efficacy	Lumens	Efficacy	Lumens	Efficacy
E4PH (IC/NIC/CP)	8W	753	92	471	60	400	50
	12W	1129	88	706	60	600	50
	17W	1600	84	1000	59	850	50
	24W	2033	80	1271	59	1080	45
E4NGH (IC/NIC/CP)	29W	2343	76	1875	60	1594	55
CRI		80+, 90+		90+		90+	
CCT OPTIONS		2700K, 3000K, 3500K or 4000K		3000K - 1800K		5000K - 2700K	
COLOR CONSISTENCY		2-step		3-step		2-step	
VOLTAGE		120V or 277V					
DIMMING¹		Standard phase and 0-10V dimming (down to 1% or 5%+ depending on wattage) Lutron Hi-lume EcoSystem (down to 0.1%) Lutron Hi-lume 2-wire (down to 1%) EldoLED 0-10V or Dali (down to 0.1%)				EldoLED 0-10V or Dali (down to 0.1%)	
POWER SUPPLY		Constant current driver with +.9 power factor and +80% efficiency					
ADJUSTABILITY		361° rotation, 45° collar rotation					
CEILING APPEARANCE		Flanged, Flangeless, Flangeless in Wood Ceiling					
CEILING THICKNESS		Flanged: Up to 1" Flangeless: No ceiling thickness limitations Flangeless in Wood Ceiling: No ceiling thickness limitations					
CEILING APERTURE		4-1/2" ceiling cutout					
HOUSING		IC Airtight, Non-IC Airtight, Chicago Plenum. IC suitable up to R60 spray foam insulation.					
CONSTRUCTION		Housing: Heavy-Gauge, Cold-Rolled Steel Trims: Die-Cast Aluminum					
FINISH		Housing: Black Powder Coat Trim: White, Black					
GENERAL LISTING		ETL Listed. Damp Listed.					
CALIFORNIA TITLE 24		Registered CEC Appliance Database. Can be used to comply with CEC 2019 Title 24 part 6 (JAB-2016, JAB-2019) (for 90 CRI versions).					
L70		50,000 hours min					
WARRANTY²		5 years					

Data in chart reflects 3000K/80CRI values unless noted. Lumen values are delivered lumens, not source lumens. Custom Output/Custom RAL/Custom CCT available, Contact Quotes Department

Ordering grids available on page 2.

¹See ELEMENT-Lighting.com for dimmer compatibility.

²Visit ELEMENT-Lighting.com for specific warranty limitations and details.

ELEMENT™ 4" PRO SERIES LED

WALL WASH DOWNLIGHT

ORDERING GRIDS

HOUSING

PRODUCT	CEILING APPEARANCE	OUTPUT	FUNCTION	HOUSING RATING	DRIVER	VOLTAGE
E4PR ELEMENT 4" PRO SERIES ROUND	L FLANGELESS	-L08 8W (750 LMS) ²	W WALL WASH	I IC AIRTIGHT	INTEGRATED DRIVERS 120V/277V	120 VOLT
E4PS ELEMENT 4" PRO SERIES SQUARE	F FLANGED	-L12 12W (1100 LMS)		N NON-IC AIRTIGHT	UNIVERSAL PHASE/0-10V 1% (LEAVE BLANK) ³	(LEAVE BLANK)
	WC WOOD CEILING ¹	-L17 17W (1600 LMS)		C CHICAGO PLENUM	-ELDO ELDOLED 0.1% 0-10V LINEAR	-2 277 VOLT
		-L24 24W (2000 LMS)			-ELDOA ELDOLED 0.1% 0-10V LOGARITHMIC	
		-L29 29W (2300 LMS)			-ELDD ELDOLED 0.1% DALI	
					-ELTO ELDOLED TUNABLE WHITE 0.1% 0-10V LINEAR ⁴	
					-ELTD ELDOLED TUNABLE WHITE 0.1% DALI ⁴	
					-HLECO LUTRON HI-LUME 0.1% ECOSYSTEM	
					INTEGRATED DRIVERS 120V	
					-HL2W LUTRON HI-LUME 1% 2-WIRE	

See Driver and Wattage Housing Compatibility Chart below for information on IC and Non-IC options.

Trims are required and must be ordered separately.

Hanger bars not included with smaller E4PH Housing. Order separately if required.

Output lists nominal wattage and lumens at 3000K/80CRI; actual wattage and lumens may vary slightly.

¹WC - Wood Ceiling accommodates Flangeless trims only. For flanged trims in a wood ceiling use standard flanged housing.

²L08 - Dimming performance with standard UNIVERSAL PHASE/0-10V driver varies dramatically from <1% to >10% depending on the dimmer; please refer to Dimmer Compatibility chart.

³The standard UNIVERSAL PHASE/0-10V driver dims to 1% with L12 and L17, and to 5% with L08, L24 and L29. Dimming performance varies by dimmer; please refer to Dimmer Compatibility chart.

⁴ELTO/ELTD - Tunable White TW52 available with -ELTO (0-10V, linear) or ELTD (DALI) only. For 0-10V logarithmic dimming consult Quotes Department.

TRIM/LIGHT MODULE

PRODUCT	CEILING APPEARANCE	FUNCTION	CRI/CCT	FINISH
E4PR ELEMENT 4" PRO SERIES ROUND	L FLANGELESS	W WALL WASH	-830 80 CRI, 3000K, 2-STEP	-W WHITE
E4PS ELEMENT 4" PRO SERIES SQUARE	F FLANGED		-835 80 CRI, 3500K, 2-STEP	-B BLACK
			-840 80 CRI, 4000K, 2-STEP	
			-927 90 CRI, 2700K, 2-STEP	
			-930 90 CRI, 3000K, 2-STEP	
			-935 90 CRI, 3500K, 2-STEP	
			-940 90 CRI, 4000K, 2-STEP	
			-WD31 90 CRI, 3000K-1800K, WARM DIM, 3-STEP ¹	
			-TW52 90 CRI, 5000K-2700K, TUNABLE WHITE, 2-STEP ²	

¹WD31 - Warm Dim not available with HL2W for L08 and L36 output, and not available with HLECO for L08, L24, and L29 output.

²TW52 - Tunable White for use with ELTO (0-10V, linear) or ELTD (DALI) Housings only. For 0-10V logarithmic dimming or TW41 4000K-1800K consult Quotes Department.

HANGER BARS

PRODUCT	STYLE
HNGBAR HANGER BAR SET	-S STANDARD
	-E ECONOMY
	-N NARROW
	-P PREMIUM ¹
HNGBAR	-

Order one set per fixture if required.

Hanger bars can be extended from 14" to 24" unless otherwise noted.

¹P - Premium Hanger Bar Set has a standard extended length from 10"-24".

To extend to 36", order two sets per fixture and join together.

To extend to 48", order three sets per fixture and join together.

DRIVER AND WATTAGE HOUSING COMPATIBILITY CHART

ITEM NUMBER	DESCRIPTION	WATTAGE						
		E4PH HOUSING				E4NG HOUSING		
		L08	L12	L17	L24	L17	L24	L29
-010	STANDARD PHASE 1% OR 5%+ DEPENDING ON WATTAGE	IC	IC	IC	NON-IC	-	IC	IC
	0-10V DIMMING 1% OR 5%+ DEPENDING ON WATTAGE	IC	IC	IC	NON-IC	-	IC	IC
-ELDO	ELDOLED 0.1% 0-10V LINEAR	IC	IC	IC	NON-IC	-	IC	IC
-ELDOA	ELDOLED 0.1% 0-10V LOGARITHMIC	IC	IC	IC	NON-IC	-	IC	IC
-ELDD	ELDOLED 0.1% DALI	IC	IC	IC	NON-IC	-	IC	IC
-ELTO	ELDOLED TUNABLE WHITE 0.1% 0-10V LINEAR	IC	IC	IC	NON-IC	-	IC	IC
-ELTD	ELDOLED TUNABLE WHITE 0.1% DALI	IC	IC	IC	NON-IC	-	IC	IC
-HL2W¹	LUTRON HI-LUME 1% 2-WIRE	IC	IC	NON-IC	NON-IC	IC	IC	NON-IC
-HLECO²	LUTRON HI-LUME 0.1% ECOSYSTEM	IC	IC	IC	NON-IC	-	IC	IC

¹HL2W - Warm Dim not available for L08 and L36 output.

²HLECO - Warm Dim not available with L08, L24 and L29 output.

ELEMENT™ 4" PRO SERIES LED

WALL WASH DOWNLIGHT

TRIMS

ROUND

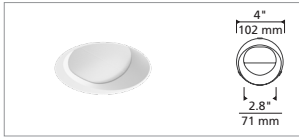

FLANGELESS



FLANGED

SQUARE

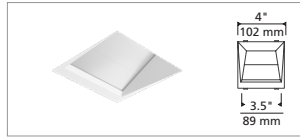

FLANGELESS

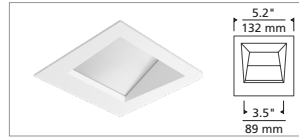

FLANGED

FINISH OPTIONS

FLANGELESS



WHITE



BLACK

FLANGED



WHITE

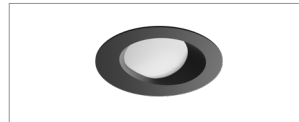

BLACK

HOUSINGS

E4PH

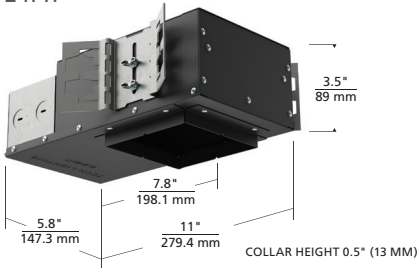

IC AIRTIGHT / NON-IC AIRTIGHT / CHICAGO PLENUM (UP TO 24W)

E4NGH

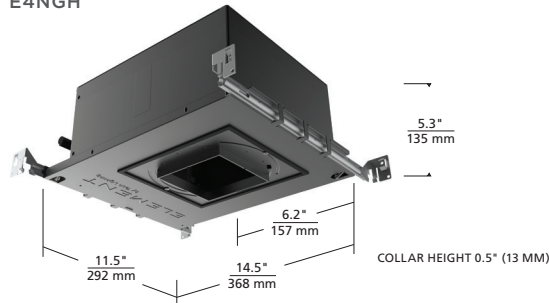

IC AIRTIGHT / NON-IC AIRTIGHT / CHICAGO PLENUM (29W)

HANGER BARS

STANDARD

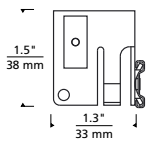

ECONOMY

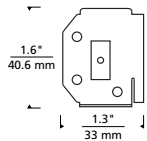

NARROW

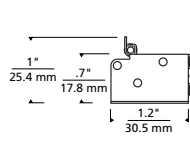

PREMIUM

