

# ELEMENT™ 4" PRO SERIES LED

## WALL WASH DOWNLIGHT

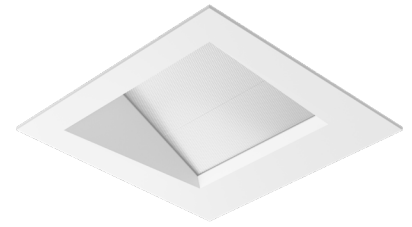

SHOWN IN FLANGED WALL WASH SQUARE

The Element 4" Pro Series Wall Wash sets a new standard for best-in-class performance. Creating a beautifully uniform high output flood of light without scalloping or hot spots. With even illumination from top to bottom of the wall, the Element 4" Pro Series Wall Wash complements the Element 4" Pro Series Fixed and Adjustable downlights for any commercial space and is available in a variety of options, including output and the choice of Static White, Warm Dim or Tunable White.

- Luminaires turning film, two directions
- Even vertical and horizontal illumination of wall
- High efficacy output: >76 lumens per watt (static white)
- 2-step standard
- Standard Triac/ELV dimming down to 1%
- Lutron/eldoLED options

### LUMEN MULTIPLIER (CRI/CCT)

CCT	80 CRI MULTIPLIER	90 CRI MULTIPLIER
2700K	0.95	0.80
3000K	1.00	0.85
3500K	1.05	0.90

Lumen output will vary by CCT and CRI. See photometric charts for output information.

### SPECIFICATIONS

		STATIC WHITE		WARM DIM		TUNABLE WHITE	
HOUSING (RATING)	Wattage	Lumens	Efficacy	Lumens	Efficacy	Lumens	Efficacy
E4PH (IC/NIC/CP)	8W	753	92	471	60	400	50
	12W	1129	88	706	60	600	50
	17W	1600	84	1000	59	850	50
	24W	2033	80	1271	59	1080	45
E4NGH (IC/NIC/CP)	29W	2343	76	1875	60	1594	55
<b>CRI</b>		80+, 90+		90+		90+	
<b>CCT OPTIONS</b>		2700K, 3000K, 3500K or 4000K		3000K - 1800K		5000K - 2700K	
<b>COLOR CONSISTENCY</b>		2-step		3-step		2-step	
<b>VOLTAGE</b>		120V or 277V					
<b>DIMMING<sup>1</sup></b>		Standard phase dimming (down to 1%)   0-10V (down to 5%) Lutron Hi-lume EcoSystem (down to 0.1%)   Lutron Hi-lume 2-wire (down to 1%) eldoLED 0-10V or Dali (down to 0.1%)				eldoLED 0-10V or Dali (down to 0.1%)	
<b>POWER SUPPLY</b>		Constant current driver with +.9 power factor and +80% efficiency					
<b>ADJUSTABILITY</b>		361° rotation, 45° collar rotation					
<b>CEILING APPEARANCE</b>		Flanged, Flangeless, Flangeless in Wood Ceiling					
<b>CEILING THICKNESS</b>		Flanged: Up to 1" Flangeless: No ceiling thickness limitations Flangeless in Wood Ceiling: No ceiling thickness limitations					
<b>CEILING APERTURE</b>		4-1/2" ceiling cutout					
<b>HOUSING</b>		IC Airtight, Non-IC Airtight, Chicago Plenum. IC suitable up to R60 spray foam insulation.					
<b>CONSTRUCTION</b>		Housing: Heavy-Gauge, Cold-Rolled Steel Trims: Die-Cast Aluminum					
<b>FINISH</b>		Housing: Black Powder Coat Trim: White, Black					
<b>GENERAL LISTING</b>		ETL Listed, Damp Listed.					
<b>CALIFORNIA TITLE 24</b>		Registered CEC Appliance Database. Can be used to comply with CEC 2019 Title 24 part 6 (JA8-2016, JA8-2019) (for 90 CRI versions).					
<b>L70</b>		50,000 hours min					
<b>WARRANTY<sup>2</sup></b>		5 years					

Data in chart reflects 3000K/80CRI values unless noted. Lumen values are delivered lumens, not source lumens. Custom Output/Custom RAL/Custom CCT available, Contact Quotes Department

Ordering grids available on page 2.

<sup>1</sup>See ELEMENT-Lighting.com for dimmer compatibility.

<sup>2</sup>Visit ELEMENT-lighting.com for specific warranty limitations and details.

# ELEMENT™ 4" PRO SERIES LED

## WALL WASH DOWNLIGHT

ORDERING GRIDS

**HOUSING**

PRODUCT	CEILING APPEARANCE	OUTPUT	FUNCTION	HOUSING RATING	DRIVER	VOLTAGE
<b>E4PR</b> ELEMENT 4" PRO SERIES ROUND	<b>L</b> FLANGELESS	<b>-L08</b> 8W (750 LMS) <sup>2</sup>	<b>W</b> WALL WASH	<b>I</b> IC AIRTIGHT	STANDARD PHASE DIMMING 1% (LEAVE BLANK)	120 VOLT (LEAVE BLANK)
<b>E4PS</b> ELEMENT 4" PRO SERIES SQUARE	<b>F</b> FLANGED	<b>-L12</b> 12W (1100 LMS)		<b>N</b> NON-IC AIRTIGHT	0-10V DIMMING 5%	<b>-2</b> 277 VOLT
	<b>WC</b> WOOD CEILING <sup>1</sup>	<b>-L17</b> 17W (1600 LMS)		<b>C</b> CHICAGO PLENUM	<b>-010</b> ELDOLED 0.1% 0-10V LINEAR	
		<b>-L24</b> 24W (2000 LMS)			<b>-ELDO</b> ELDOLED 0.1% 0-10V LOGARITHMIC	
		<b>-L29</b> 29W (2300 LMS) <sup>3</sup>			<b>-ELDOA</b> ELDOLED 0.1% 0-10V LOGARITHMIC	
					<b>-ELD1</b> ELDOLED 1% 0-10V LINEAR	
					<b>-ELD1A</b> ELDOLED 1% 0-10V LOGARITHMIC	
					<b>-ELDD</b> ELDOLED 0.1% DALI	
					<b>-ELTO</b> ELDOLED TUNABLE WHITE 0.1% 0-10V LINEAR <sup>4</sup>	
					<b>-ELTD</b> ELDOLED TUNABLE WHITE 0.1% DALI <sup>4</sup>	
					<b>-HL2W</b> LUTRON HI-LUME 1% 2-WIRE <sup>5</sup>	
					<b>-HLECO</b> LUTRON HI-LUME 0.1% ECOSYSTEM <sup>6</sup>	
		-	<b>W</b>			

Trims are required and must be ordered separately.

Hanger bars not included with E4PH housing. Order separately if required.

Output lists nominal wattage and lumens at 3000K/80CRI; actual wattage and lumens may vary slightly.

<sup>1</sup>WC - Wood Ceiling accommodates Flangeless trims only. For flanged trims in a wood ceiling use standard flanged housing.

<sup>2</sup>L08 - Output min standard phase dimming level may be 5% or greater.

<sup>3</sup>L29 - Output available only in E4NGH Housing.

<sup>4</sup>ELTO/ELTD - Tunable White TW52 available with -ELTO (0-10V, linear) or -ELTD (DALI) only. For 0-10V logarithmic dimming consult Quotes Department.

<sup>5</sup>HL2W - Lutron 2-wire low-voltage electronic dimming, 120V only. Not available with WD31 Warm Dim for L08 output. Available IC in E4PH Housing only with L08 and L12 output.

Available IC/Non-IC/CP in E4NGH Housing with L17, and L24 output. Available Non-IC/CP in E4PH Housing only with L08, L12, L17, and L24 output.

<sup>6</sup>HLECO - Lutron EcoSystem available with WD31 Warm Dim only for L12 and L17 output.

**TRIM/LIGHT MODULE**

PRODUCT	CEILING APPEARANCE	FUNCTION	CRI/CCT	FINISH
<b>E4PR</b> ELEMENT 4" PRO SERIES ROUND	<b>L</b> FLANGELESS	<b>W</b> WALL WASH	<b>-830</b> 80 CRI, 3000K, 2-STEP	<b>-W</b> WHITE
<b>E4PS</b> ELEMENT 4" PRO SERIES SQUARE	<b>F</b> FLANGED		<b>-835</b> 80 CRI, 3500K, 2-STEP	<b>-B</b> BLACK
			<b>-840</b> 80 CRI, 4000K, 2-STEP	
			<b>-927</b> 90 CRI, 2700K, 2-STEP	
			<b>-930</b> 90 CRI, 3000K, 2-STEP	
			<b>-935</b> 90 CRI, 3500K, 2-STEP	
			<b>-940</b> 90 CRI, 4000K, 2-STEP	
			<b>-WD31</b> 90 CRI, 3000K-1800K, WARM DIM, 3-STEP <sup>1</sup>	
			<b>-TW52</b> 90 CRI, 5000K-2700K, TUNABLE WHITE, 2-STEP <sup>2</sup>	
		<b>W</b>	-	-

<sup>1</sup>WD31 - Warm Dim not available with HL2W for L08 and L36 output, and not available with HLECO for L08, L24, and L29 output.

<sup>2</sup>TW52 - Tunable White for use with -ELTO (0-10V, linear) or -ELTD (DALI) Housings only. For 0-10V logarithmic dimming or TW41 4000K-1800K consult Quotes Department.

**HANGER BARS**

PRODUCT	STYLE
<b>HNGBAR</b> HANGER BAR SET	<b>-S</b> STANDARD
	<b>-E</b> ECONOMY
	<b>-N</b> NARROW
	<b>-P</b> PREMIUM <sup>1</sup>
	-

**HNGBAR**

Order one set per fixture if required.

Hanger bars can be extended from 14" to 24" unless otherwise noted.

<sup>1</sup>P - Premium Hanger Bar Set has a standard extended length from 10"-24".

To extend to 36", order two sets per fixture and join together.

To extend to 48", order three sets per fixture and join together.

# ELEMENT™ 4" PRO SERIES LED

## WALL WASH DOWNLIGHT

TRIMS

ROUND

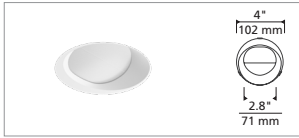

FLANGELESS



FLANGED

SQUARE

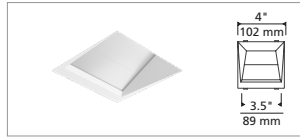

FLANGELESS

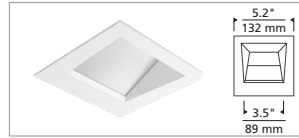

FLANGED

FINISH OPTIONS

FLANGELESS



WHITE



BLACK

FLANGED



WHITE

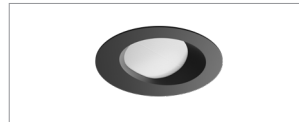

BLACK

HOUSINGS

E4PH

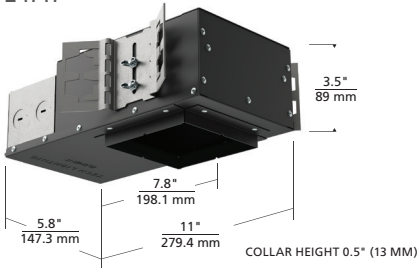

IC AIRTIGHT / NON-IC AIRTIGHT / CHICAGO PLENUM (UP TO 24W)

E4NGH

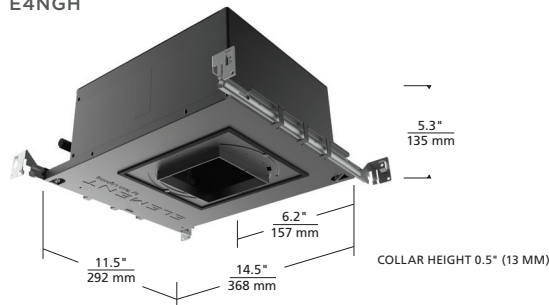

IC AIRTIGHT / NON-IC AIRTIGHT / CHICAGO PLENUM (29W)

HANGER BARS

STANDARD

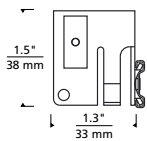

ECONOMY

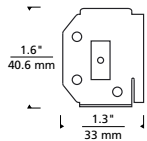

NARROW

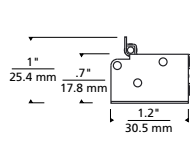

PREMIUM

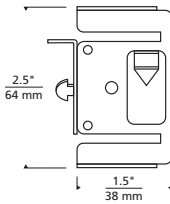

# ELEMENT™ 4" PRO SERIES LED

WALL WASH DOWNLIGHT

**PROJECT INFORMATION**

---

**JOB NAME AND INFORMATION**

---

---

---

---

---

---

---

---

---

---

---

**FIXTURE TYPE AND QUANTITY**

---

---

---

---

---

---

---

---

---

---

---

**NOTES**

---

---

---

---

---

---

---

---

---

---

---

---

---

---

---

---

---

---

---

---

---

---

---

---