

REFLECTIONS

SKYE FLANGED INDIRECT DOWNLIGHT

Innovative, first-of-its-kind technology in architectural downlights, ELEMENT Reflections combines decorative recessed domes with beautifully controlled, reduced-glare indirect LED illumination. ELEMENT Reflections domes (available in 5", 8" and 12" diameters) are recessed into the ceiling plane and act as reflectors to a completely hidden ring of up-firing LEDs.

The Skye dome transforms beautiful three-dimensional geometry for dramatic visual interest with the subtle play of light and shadow. All ELEMENT Reflections domes also offer two ceiling appearance options: flanged for a more traditional ceiling appearance; or flangeless for a smooth, mudded-in ceiling appearance.

Pristine design and illumination:

- Reduced glare, indirect illumination (dimnable for enhanced mood-setting options)
- Three Aperture Options: 5", 8" and 12"
- Beveled, rounded trim edges smoothly and seamlessly integrate into ceiling

Housing and Trim/Dome sold separately.

High quality LM80-tested LEDs

for consistent long-life performance and color

SPECIFICATIONS

	5"	8"	12"
DELIVERED LUMENS	684	1255	1989
WATTS	9	15	31
VOLTAGE	Universal 120V-277V		
DIMMING*	0-10V, ELV, TRIAC (Down to 5%) Lutron Hi-Lume Eco-system Fade-to-Black (Down to 0.1%) Lutron Hi-Lume 2-wire (Down to 1%) EldoLED 0-10V or Dali (Down to 0.1%)		
POWER SUPPLY	Constant current driver with +.9 power factor and +85% efficiency. Servicable from below the ceiling.		
LIGHT DISTRIBUTION	Lambertian		
CCT	2700K, 3000K, 3500K, or Warm Color Dimming (3000K-2000K)		
CRI	90+		
CEILING APPEARANCE	Flanged (Trims accommodate a 1/2" to 1" ceiling thickness)		
HOUSING	IC Airtight or Chicago Plenum. IC suitable up to R60 spray foam insulation.		
GENERAL LISTING	ETL listed, Damp listed		
CALIFORNIA TITLE 24	Registered CEC Appliance Database. Can be used to comply with CEC 2016 Title 24 Part 6.		
LED LIFETIME	L70; 50,000 Hours		
WARRANTY**	5 Years		

*See ELEMENT-lighting.com for dimmer compatibility.

**Visit ELEMENT-lighting.com for specific warranty limitations and details.



SKYE
shown in flanged

ORDERING INFORMATION

HOUSING

PRODUCT SERIES	HOUSING RATING	DRIVER
EDIH5R	I IC AIRTIGHT	ELV/TRIAC/0-10V UNV** (LEAVE BLANK)
EDIH8R	C CHICAGO PLENUM	-ELDD ELDLED 0.1% 0-0V LINEAR UNV**
EDIH12R		-ELDD0A ELDLED 0.1% 0-0V LOGARITHMIC UNV**
		-ELD1 ELDLED 1% 0-0V LINEAR UNV**
		-ELD1A ELDLED 1% 0-0V LOGARITHMIC UNV**
		-ELDD ELDLED 0.1% DALI UNV**
		-HLECO HI-LUME ECO-SYSTEM FADE-TO-BLACK UNV**
		-HL2W HI-LUME 2-WIRE*

MUST ORDER LED DOME (SOLD SEPARATELY). *HL2W = 120V INPUT VOLTAGE ONLY.

**ALL DRIVERS EXCEPT LUTRON HL2W ARE UNV = 120V/277V INPUT VOLTAGE.

TRIM/DOME

PRODUCT SERIES	CEILING APPEARANCE	CRI/CCT	DOME PATTERN	FINISH
EDIT5R	F FLANGED	927 90CRI, 2700K	1 SKYE	W WHITE
EDIT8R		930 90CRI, 3000K		
EDIT12R		935 90CRI, 3500K		
		9WD 90CRI, WARM DIM 3000K-2000K		

REFLECTIONS

SKYE FLANGED INDIRECT DOWNLIGHT

techlighting.com

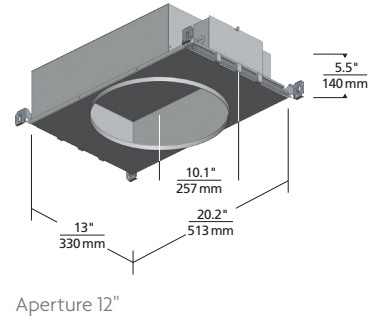
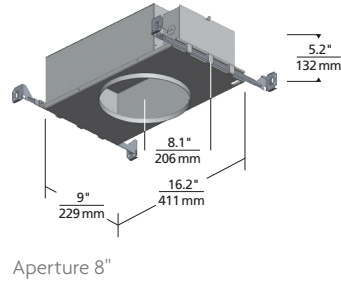
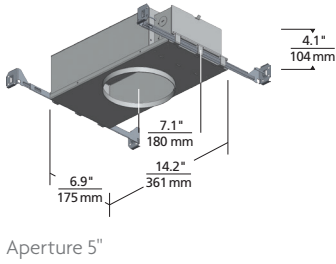
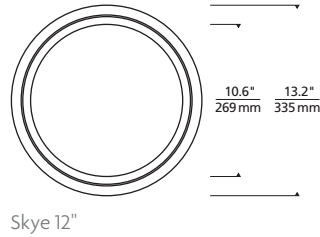
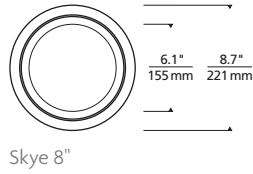
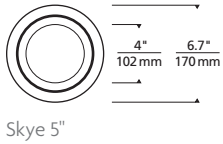

PHOTOMETRICS*

*For latest photometrics, please visit www.ELEMENT-Lighting.com

SKYE FLANGED 5"

Total Lumen Output:	684
Total Power:	9
Luminaire Efficacy:	76
Color Temp:	3000K
CRI:	90+

SKYE FLANGED 8"

Total Lumen Output:	1255
Total Power:	15
Luminaire Efficacy:	84
Color Temp:	3000K
CRI:	90+

SKYE FLANGED 12"

Total Lumen Output:	1989
Total Power:	31
Luminaire Efficacy:	64
Color Temp:	3000K
CRI:	90+

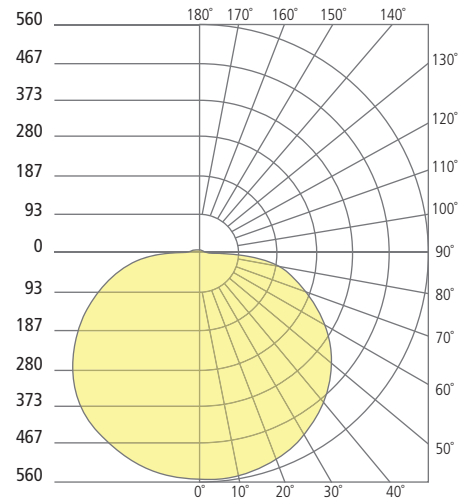
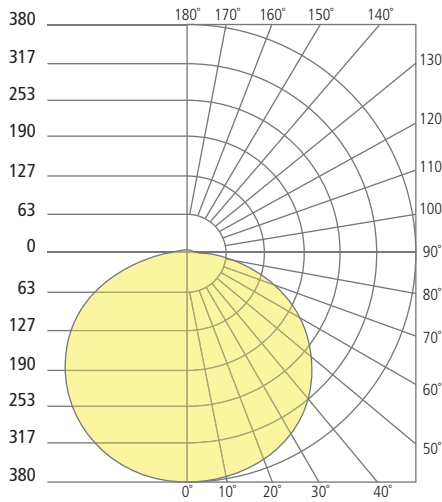
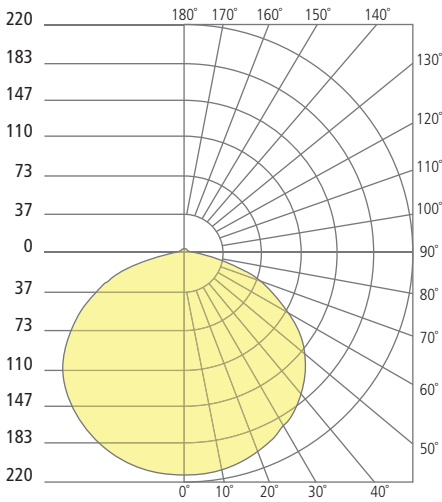

PROJECT INFO

FIXTURE TYPE & QUANTITY

JOB NAME & INFO

NOTES



2019 Tech Lighting, L.L.C. All rights reserved. The "Tech Lighting" graphic is a registered trademark. Tech Lighting reserves the right to change specifications for product improvements without notification.

TECH LIGHTING
VISUAL COMFORT GROUP

7400 Linder Avenue, Skokie, Illinois 60077
T 847.410.4400 F 847.410.4500