

# Square and Round Flat Trims for 4" Element

E4\_F\_

1.1



## GENERAL PRODUCT INFORMATION:

This product is suitable for indoor locations.

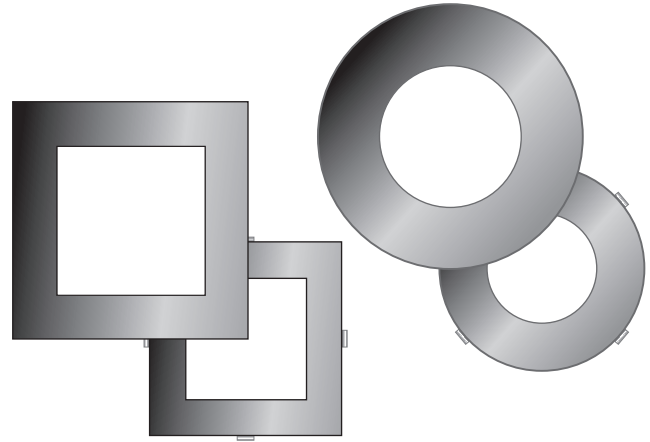

## Preparation for Installation

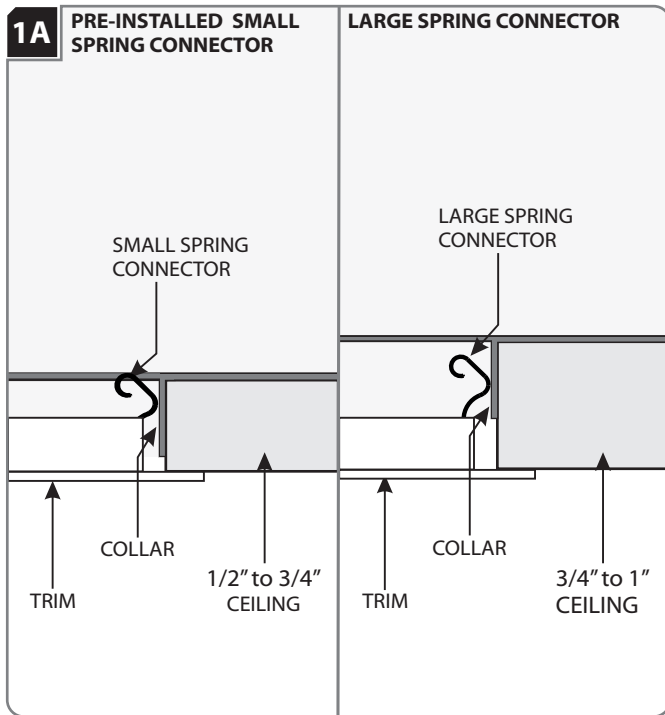

- 1 The pre-installed springs are intended for ceiling thicknesses from 1/2" to 3/4". Skip to section 2 if the ceiling thickness is 1/2" to 3/4".
- 2 For ceiling thicknesses from 3/4" to 1", follow the rest of this section to replace the trim springs.

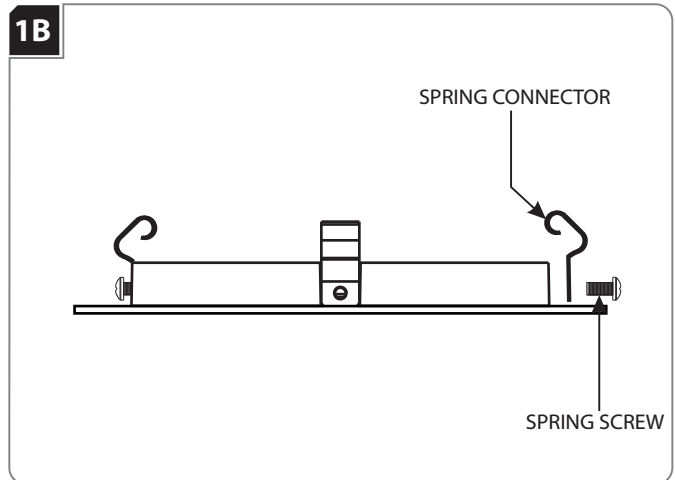

- 3 Replace the pre-installed spring connectors by removing the spring screws.

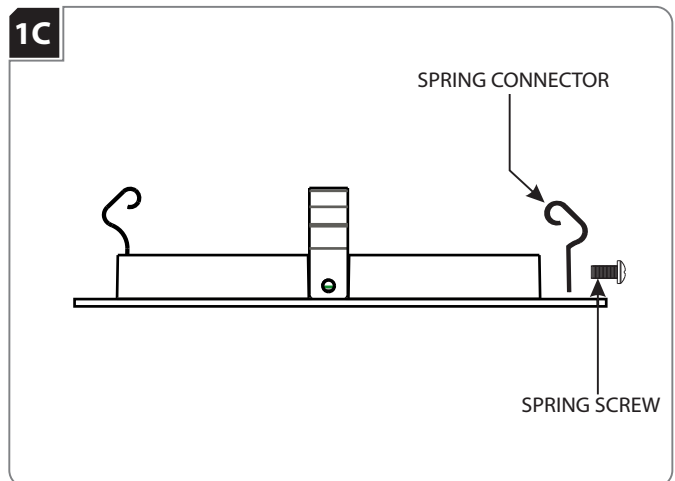

- 4 Install the large spring connectors and secure them by reinstalling the spring screws.

## Install the Trim

2A

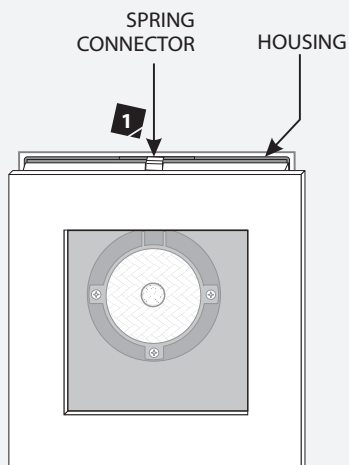

- 1 Align the trim spring connectors with the inner edge of the housing.

2B

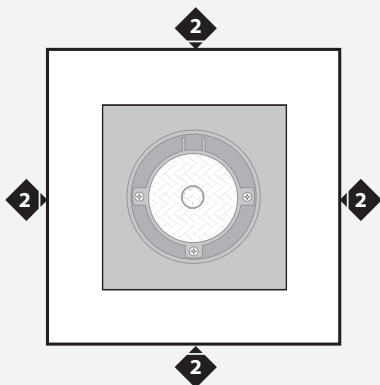

- 2 Gently push the trim into the housing so that the four spring connectors snap into place.

**NOTE:** For flangeless trims, the spring connectors on the trim snap into the plaster plate.

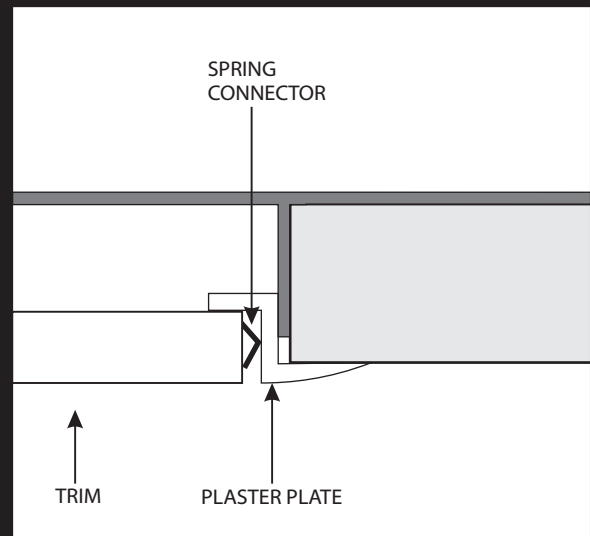

**SAVE THESE INSTRUCTIONS!**

 **TECH LIGHTING**

7400 Linder Ave., Skokie, IL 60077

T 847.410.4400 | F 847.410.4500

[www.techlighting.com](http://www.techlighting.com)